

3 YEAR
WARRANTY

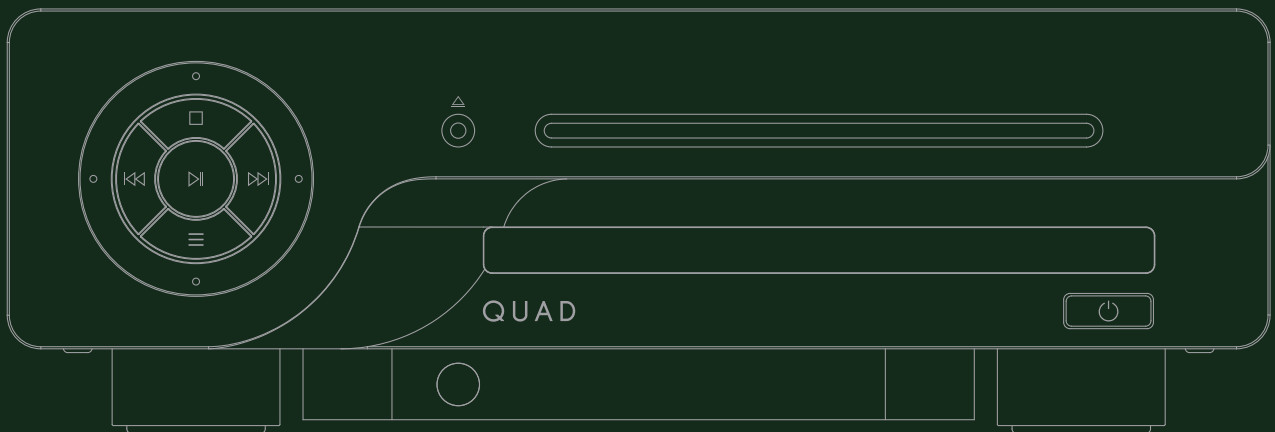

*Scan the QR code using a smart-phone device,
for product warranty registration online.*

QUAD 3CDT



CD Transport

User Manual

QUAD

the closest approach to the original sound

IMPORTANT SAFETY INFORMATION



This lightning flash with arrowhead symbol within an equilateral triangle is intended to alert the user to the presence of non-insulated "dangerous voltage" within the product's enclosure that may be of sufficient magnitude to constitute a risk of electric shock.

Warning: To reduce the risk of electric shock, do not remove the cover (or back) as there are no user-serviceable parts inside. Refer servicing to qualified personnel.

This exclamation point within an equilateral triangle is intended to alert the user to the presence of important operating and maintenance instructions in the literature accompanying the appliance.

Read these instructions.

Keep these instructions.

Heed all warnings.

Follow all instructions.

Do not use this apparatus near water.

Clean only with dry cloth.

Do not block any ventilation openings. Install in accordance with the manufacturer's instructions.

Do not install near any heat sources such as radiators, heat registers, stoves, or other apparatus (including amplifiers) that produce heat.

Do not defeat the safety purpose of the polarised or grounding plug. A grounding plug has two blades and a third grounding prong. The wide blade or the third prong is provided for your safety. If the provided plug does not fit into your outlet, consult an electrician for replacement of the obsolete outlet.

Protect the power cord from being walked on or pinched particularly at the plugs, convenience receptacles, and at the point where they exit from the apparatus.

Unplug this apparatus during lightning storms or when unused for long periods of time.

Refer all servicing to qualified service personnel. Servicing is required when the apparatus has been damaged in any way, such as power supply cord or plug is damaged, liquid has been spilled or objects have fallen into the apparatus, the apparatus has been exposed to rain or moisture, does not operate normally, or has been dropped.

WARNING: Only use attachments/accessories specified or provided by the manufacturer (such as the recommended battery - not supplied).

WARNING: The mains plug/appliance coupler/is used as disconnection device; the disconnection device shall remain readily operable.

CAUTION: These servicing instructions are for use by qualified service personnel only. To reduce the risk of electric shock, do not perform any servicing other than that contained in the operating instructions unless you are qualified to do so.

Do not install this equipment in a confined or built-in space such as a bookcase or similar unit, and keep well ventilated in open space. The ventilation should not be impeded by covering the ventilation openings with items such as newspaper, table-cloths, curtains etc.

WARNING: To reduce the risk of fire or electric shock, do not expose this apparatus to rain or moisture. The apparatus shall not be exposed to dripping or splashing and ensure that objects filled with liquids, such as vases, shall not be placed on the apparatus. No naked flame sources, such as lighted candles, should be placed on the apparatus.

WARNING: Do not ingest the battery, Chemical Burn Hazard. This product requires a coin/button cell battery (not included). If the coin/button cell battery is swallowed, it can cause severe internal burns in just 2 hours and can lead to death. Keep new and used batteries away from children. If the battery compartment does not close securely, stop using the product and keep it away from children. If you think batteries might have been swallowed or placed inside any part of the body, seek immediate medical attention.



Ground protection terminal. This product should be connected to a power outlet with ground protection.

Denmark: Apparatets stikprop skal tilsluttes en stikkontakt med jord, som giver forbindelse til stikproppens jord.

Finland: Laite on liitettävä suojakoskettimilla varustettuun pistorasiaan.

Norway: Apparatet må tilkoples jordet stikkontakt.

Sweden: Apparatens skall anslutas till jordat uttag.



This label tells you that the unit contains a laser component. Opening the unit will expose the user to radiation from the laser. The apparatus with CLASS I construction shall be connected to a mains socket outlet with a protective earthing connection.

QUAD 3CDT

CONTENTS

| | |
|------------------------------|----|
| INTRODUCTION | 3 |
| CONTROLS AND FUNCTIONS | 4 |
| CONNECTIONS | 5 |
| REMOTE HANDSET | 6 |
| MENU OPTIONS | 7 |
| WARRANTY COVERAGE | 8 |
| SPECIFICATIONS | 11 |

INTRODUCTION

Thank you for your investment in the QUAD 3CDT. We are sure that the QUAD 3CDT will continue to delight you for years to come.

The QUAD 3CDT is a dedicated CD transport designed to the high standards of QUAD audiophile equipment.

The QUAD 3CDT uses a high-precision optical system with an electronic data buffer for accurate and seamless CD playback.

Please read this manual carefully to help you get the most from your QUAD 3CDT device.

Features

- High-end CD mechanism with a precision optical system
- Playback from CD
- Automatic equipment activation via 12V trigger input
- Illuminated LCD screen

UNPACKING THE EQUIPMENT

The carton contains:

- The QUAD 3CDT
- One IEC mains cable with a plug suitable for your region
- One remote controller
- A QUAD 3CDT user manual
- 2 x AAA batteries

Consult the dealer from whom you purchased the equipment if any item is not present. Carefully unpack the unit and accessories. Take care not to damage the surface finish when undoing the protective polythene sleeve. Retain the packing materials for future use. Retain the user manual and information concerning the date and place of purchase of your equipment for future reference. If you transfer the unit to a third party please pass on this instruction manual along with the equipment.

PLACEMENT

The unit must be mounted on a solid, level and stable surface. Before you connect the QUAD 3CDT to AC mains power, ensure your AC mains voltage corresponds to the rating on the rear panel of the product. If in doubt, consult your dealer. If you move to a region which has a different mains voltage, seek advice from a QUAD appointed dealer or a competent service technician.

CONTROLS AND FUNCTIONS

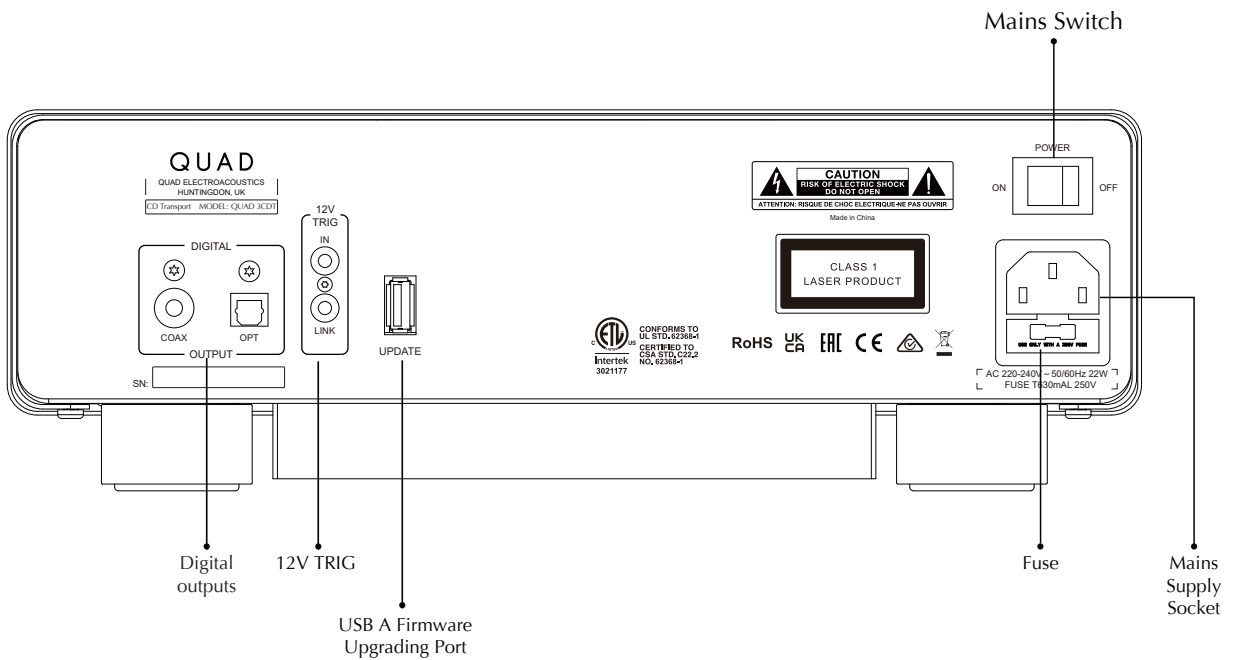
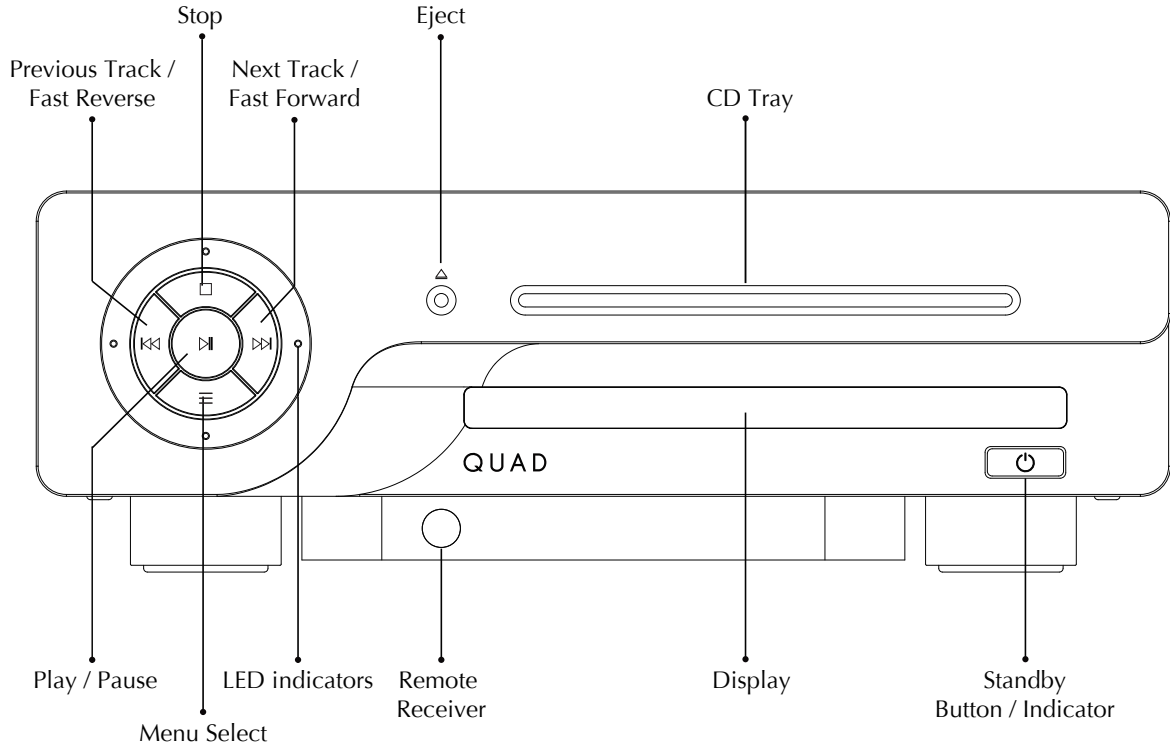

CONNECTIONS

USB Update

Any official QUAD 3CDT update will be provided and available by download from quad-hifi.co.uk



Please read and follow any instructions provided with any such download.

POWER OFF the QUAD 3CDT unit. Insert the USB storage device onto which the USB update files have been loaded. Press the 'Standby' button on the front panel, then simultaneously POWER ON. The QUAD 3CDT will upgrade automatically. Wait for the device display to confirm that the update is completed. Then, unplug the USB drive and restart the QUAD 3CDT. The unit is now ready to use.

12V Trigger Connection

The input should be used to receive a trigger signal from a compatible amplifier (such as the QUAD 3), and the link can be used to trigger other compatible devices and models. The connection should be made with a 3.5mm to 3.5mm stereo or mono jack interconnect.

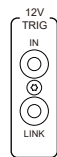

Please note that the link out will only work if a 12V trigger cable is connected to the input.

Coaxial and Optical Output

The QUAD 3CDT offers one Coaxial and one Optical SPDIF digital output. Connect a suitable Digital Coaxial (fully screened) or Optical cable from the appropriate SPDIF output of the QUAD 3CDT to the input of a DAC or digital input on your chosen preamplifier.

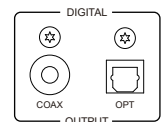

Mains Input

Before connecting the AC power cord to the QUAD 3CDT, please make sure the Power Switch is in the OFF position. Switch it to the ON position after connecting the unit to the AC mains.

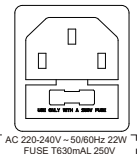

REMOTE HANDSET

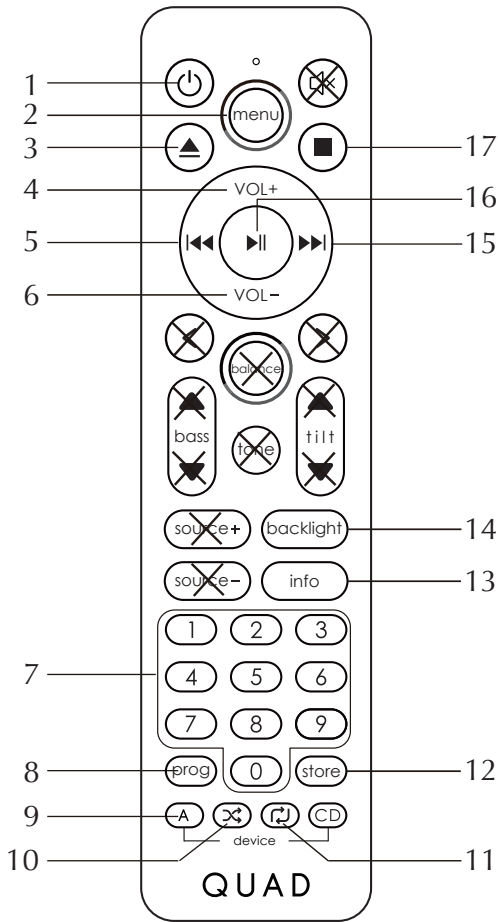

- | | |
|----------------------|---|
| 1. Standby | Press to put the unit in, or bring it out of 'standby' |
| 2. Menu | Press to access settings menu |
| 3. ▲ | Press to eject / load the disc |
| 4. Volume + | Navigate settings menu |
| 5. ⏮ | Skip track backwards / navigate settings menu |
| 6. Volume - | Navigate settings menu |
| 7. Number Keys | Press to go directly to a track by number. |
| 8. Prog | Press to program tracks of your choice. |
| 9. Mode Option | Press to select the device - A/CD (this allows owners of QUAD 3 integrated amplifier and QUAD 3CDT to use a single remote control). |
| 10. ∞ | Press to select random mode |
| 11. ↺ | Press to select the repeat mode. |
| 12. Store | Press to store a track in program mode. |
| 13. Info | Press to switch between time elapsed or remaining of playback |
| 14. Backlight switch | Short press turns backlight ON/OFF. Long press to access backlight menu. |
| 15. ⏮ | Skip track forwards / navigate settings menu Play / |
| 16. ▶ | pause and make selections in the settings menu |
| 17. ■ | Press to stop |

Fit the Batteries

Open the cover and insert 2 x AAA batteries, replace the cover. Always use AAA batteries and replace them in sets – never mix up old and new batteries. Very weak batteries can leak and damage the handset. Replace them in good time!

Note: there is a risk of fire and injury if a battery is handled improperly. Do not disassemble, crush, puncture, short the contacts or dispose of the batteries in fire or water. Do not attempt to open or service a battery. Discard used batteries in full accordance with recycling regulations in force in your region.

Handset Operation

Point the handset at the remote receiver and press the buttons as illustrated to activate the relevant functions. The handset should be within 15 metres of the player and there should be a clear line of sight between the handset and the unit for optimum remote control operation.

Note:

The buttons shown crossed out are for use with the QUAD 3 Integrated amplifier and offer no function on the QUAD 3CDT.

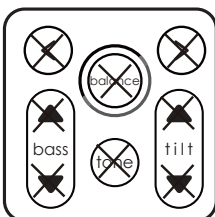

Programmed Play

You can set a 'programmed' playback order for CD tracks on the QUAD 3CDT. The Programming mode is only accessible when a CD is inserted and the QUAD 3CDT is idle ie. the disc is not playing.

To enter the Programming mode, press the 'prog' button on the remote controller. Enter the first track that you would like to play by entering the tracking number using the number pad on the remote. Press 'store' to save the chosen track in position (1). Enter the next track number using the number pad, and press 'store' to save in position (2), and so on.

Once you have populated your tracklist, scroll left and right using the ◀◀ and ▶▶ buttons on the remote control to select which track you would like to start playing from. For example, to play from the beginning of your programmed list, scroll left to the first stored track.

Begin playback by pressing the ▶| button. Playback of your programmed list will start, beginning with the currently selected track. Press the ■ button to stop the programmed playback.

To exit the 'Programmed' playback mode, press the ■ button twice.

MENU OPTIONS

-< BACKLIGHT >-

The backlight can be adjusted from 'Off' or to various brightness settings from Level 1 - 3.

-< CONTRAST >-

The display contrast can be adjusted through Level 1 - 5

-< DISPLAY TEXT >-

You can set the display text ON and OFF.

-< TRIGGER >-

Activate or deactivate the 12V trigger function of the QUAD 3CDT.

-< AUTO STANDBY >-

The auto standby feature will, by default, put the unit into standby after 20 minutes of inactivity.

This feature can be configured and set to 20 minutes, 60 minutes or 'never'.

-< RESET >-

Reset the QUAD 3CDT to the factory default settings.

-< VERSION >-

Check the currently installed firmware version.

WARRANTY COVERAGE

QUAD warrants its products, subject to the following terms and conditions below, to be free from defects in materials and workmanship.

Online Registration



Scan the QR code using a smart-phone device, for product warranty registration online.

The three (3) year extended warranty is applicable to items purchased from Jan 1st 2021, onwards. Items purchased prior to this date are not eligible for this extended warranty service but are subject to statutory warranty claims and all applicable consumer rights.

To qualify for the extended 3 year warranty, you must register your product within ninety (90) calendar days from the date of purchase. Visit <https://www.quad-hifi.co.uk/warranty-registration> to complete your online registration. Items not registered online will have a Limited Warranty for one (1) year, or for the period of your country's statutory warranty, whichever is longer.

Warranty can only be offered to products registered with proof of purchase with date, model and details of the authorised dealer clearly stated on the receipt/invoice. Please keep the original receipt/invoice in case it is required for a warranty claim.

This Limited Warranty is non-transferable and is offered exclusively to the original owner.

This Limited Warranty is valid only in the original country of purchase.

Repairs or replacements are provided under this warranty are the exclusive remedy of the consumer. QUAD shall not be liable for any incidental or consequential damages for breach of any expenses or implied warranty with any product. Except to the extent prohibited by law, this warranty is exclusive and in lieu of all other warranties whatsoever, both expressed and implied, including but not limited to the warrant of merchantability and fitness for practical purpose.

This warranty provides benefits that are additional to and do not affect your statutory consumer rights.

This Limited Warranty offer is subject to correct information being submitted in your application. Incorrect dates or mismatched purchase receipt dates that are outside of the warranty terms will immediately invalidate any warranty claim.

*Please check with your dealer local distributor for further information.

Exclusions

The following items are excluded from the QUAD warranty:

Normal wear and tear and cosmetic damage (including but not limited to any wear from reasonable use, environmental deterioration or neglect)

Products on which the serial number has been removed, altered or otherwise made illegible.

Products not purchased from an authorised QUAD dealer.

Products that were not new at the time of original purchase.

Products sold 'as is', 'as seen' or 'with faults'.

Product not purchased from an Authorised Dealer/Distributor within the region of the claim (ie parallel imports or grey market products)

Accidental damage or faults caused by commercial use, acts of God, incorrect installation, incorrect connection, incorrect packaging, misuse or careless operation or handling which is not in accordance with the user instructions.

Equipment that has been operated in conjunction with unsuitable, inappropriate or faulty apparatus.

Repairs, alterations or modifications carried out by parties other than QUAD or its authorised service partners.

Damage in transit that cannot be attributable to the fault of QUAD, the authorised distributor or dealer (ie. claims otherwise covered by transit insurance.)

Faults relating to abnormal or inappropriate power supply voltage or power surges.

Faults relating to extremities in temperature, exposure to heat, water or other liquids, insects, excessive moisture, sand, chemicals, battery leakage or any other contaminants.

Any force majeure events, including but not limited to any acts of God, fire, lightning, typhoon, storm, earthquake, hurricane, natural disaster, tsunami, flood, war, riot, public disturbance.

Any other causes beyond the reasonable control of either QUAD and its Authorised Distributor.

Please note items purchased before 1st Jan 2021 are not eligible for the extended warranty claim.

How to Claim

To obtain warranty service please contact the authorised dealer from which you purchased this product and present the limited warranty certificate offered upon registration of your product's extended warranty offer.

Do not dispatch goods without the prior agreement of the dealer distributor or authorised service centre.

If asked to return products for inspection and or repair, please pack carefully preferably in the original carton or packaging affording an equal degree of protection and returned via insured, trackable courier service.

The authorised dealer or distributor will offer full return details and instructions. However, please note if unsuitable packaging is used the warranty may be deemed void due to improper action in return.

QUAD or the authorised distributor, dealer or service centre may make a charge for the supply of new packaging for the return of the repaired item. Please note, insurance is recommended as goods are returned at the owner's risk. Authorised distributors or service centres can not be held liable for loss or damage in transit. insurance and freight charges on the return journey will be paid for by QUAD, authorised dealer, distributor or service centre if corrective work proves to be necessary.

In the event of 'no-fault found' or 'no repair necessary', the return shipping charge will be the responsibility of the owner.

Repairs

All repairs will be carried out by the appointed distributor (or locally appointed service centre). Repairs handled or processed without authorisation or approval of the appointed representative will be excluded from this limited warranty. Please note, QUAD is not able to supply parts or replacement items to any other entity than the official distributor or authorised service centre.

Other than the warranty and services set out in this warranty, to the fullest extent permitted by law, QUAD shall not be liable to you and/or any third party or entity whatsoever for:

- Any loss, damages and/or malfunction caused to any product(s) which is/are connected to any of the products covered by this warranty.
- Any damages, loss and liability, whether direct, indirect, incidental, consequential special, punitive or otherwise, howsoever caused by, arising out of or otherwise, in relation to the installation, delivery, use, service, repair, replacement and/or maintenance of the product;
- Any damages, loss and liability under this warranty in respect of any act, omission, or negligence of any of their technicians, employees, agents, representatives or independent contractors relating to the actual or purported performance of any of the obligations under this warranty.

Service Centre Address

For technical support, servicing or product queries and information please contact either your local retailer or the office below.

IAG Service Dept.
13/14 Glebe Road
Huntingdon
Cambridgeshire
PE29 7DL
UK

Tel: +44(0)1480 452561

Email: service@quad-hifi.co.uk

For information on other authorised service centres worldwide contact QUAD International, UK.
A world wide distributors list is available on the QUAD website: www.quad-hifi.co.uk

SPECIFICATIONS

| Model | QUAD 3CDT |
|--|--|
| General description | CD transport |
| Design philosophy and core technology | Compatible with CD/CD-R/CD-RW Illuminated display 10.9 x 159mm large size full view LCD screen Remote control functionality |
| Digital output amplitude | 500 +/-50mVpp |
| Output impedance | 75Ω |
| Frequency response | -0.01 dB (20Hz-20kHz, ref 1 kHz) |
| Sampling Rate | 44.1kHz |
| Digital output interface | 1 x Coaxial, 1 x Optical |
| Standby power consumption | <0.5W |
| Power requirements (according to region) | 220-240V - 50/60Hz 100-120V - 50/60Hz |
| Product size WxHxD(mm) | 300 x 300 x 101 |
| Carton size WxHxD(mm) | 420 x 366 x 215 |
| Net weight | 5.37Kg |
| Gross weight | 7Kg |



Correct Disposal of this product. This marking indicates that this product should not be disposed with other household wastes throughout the EU. To prevent possible harm to the environment or human health from uncontrolled waste disposal, recycle it responsibly to promote the sustainable reuse of material resources. To return your used device, please use the return and collection systems or contact the retailer where the product was purchased. They can take this product for environmental safe recycling.

QUAD





QUAD

IAG House, 13/14 Glebe Road, Huntingdon, Cambridgeshire, PE29 7DL, UK
Tel: +44(0)1480 452561 Email: service@QUAD-hifi.co.uk <http://www.QUAD-hifi.co.uk>
IAG reserves the right to alter the design and specifications without notice. All rights reserved © IAG Group Ltd.
QUAD is a member of the International Audio Group.