



AT-SP3X

Powered Bookshelf Speakers

User Manual

Safety precautions

Although this product was designed to be used safely, failing to use it correctly may result in an accident. To ensure safety, observe all warnings and cautions while using the product.

Important information

Warning

To prevent fire or shock hazard, do not expose this apparatus to rain or moisture.

Caution

- Do not expose this apparatus to drips or splashes.
- To avoid electric shock, do not open the cabinet.
- Refer servicing to qualified personnel only.
- Do not expose this apparatus to excessive heat such as sunshine, fire or the like.
- Do not subject this apparatus to strong impact.
- This apparatus should be located close enough to the AC outlet so that you can easily grasp the AC adapter at any time.
- In case of emergency, disconnect the AC adapter quickly.
- Do not place any objects filled with liquids, such as vases, on this apparatus.
- To prevent fire, do not place any naked flame sources (such as lighted candles) on this apparatus.
- Do not install this apparatus in a confined space such as a bookcase or similar unit.
- Install this apparatus only in the place where ventilation is good.

For customers in the USA

FCC Notice

Warning

This device complies with Part 15 of the FCC Rules. Operation is subject to the following two conditions: (1) This device may not cause harmful interference, and (2) this device must accept any interference received, including interference that may cause undesired operation.

Caution

You are cautioned that any changes or modifications not expressly approved in this manual could void your authority to operate this equipment.

Safety precautions

Note: This equipment has been tested and found to comply with the limits for a Class B digital device, pursuant to part 15 of the FCC Rules. These limits are designed to provide reasonable protection against harmful interference in a residential installation. This equipment generates, uses and can radiate radio frequency energy and, if not installed and used in accordance with the instructions, may cause harmful interference to radio communications. However, there is no guarantee that interference will not occur in a particular installation. If this equipment does cause harmful interference to radio or television reception, which can be determined by turning the equipment off and on, the user is encouraged to try to correct the interference by one or more of the following measures:

- Reorient or relocate the receiving antenna.
- Increase the separation between the equipment and receiver.
- Connect the equipment into an outlet on a circuit different from that to which the receiver is connected.
- Consult the dealer or an experienced radio/TV technician for help.

This transmitter must not be co-located or operated in conjunction with any other antenna or transmitter used in other systems.

RF Exposure Statement

This device complies with FCC radiation exposure limits set forth for an uncontrolled environment and meets the FCC radio frequency (RF) Exposure Guidelines. This equipment has very low levels of RF energy that it deemed to comply without maximum permissive exposure evaluation. (MPE). But it is desirable that it should be installed and operated keeping the radiator at least 20 cm or more away from person's body.

Contact

Responsible Company: Audio-Technica U.S., Inc.

Address: 1221 Commerce Drive, Stow, Ohio 44224, USA

Tel: 330-686-2600

For customers in Canada

ISED statement

CAN ICES-003 (B)/NMB-003(B)

This device complies with RSS-102 radiation exposure limits set forth for an uncontrolled environment.

This equipment should be installed and operated with minimum distance 20 cm between the radiator and your body.

Notes on use

- Be sure to read the connected device's user manual before use.
- Audio-Technica will not be liable in any way for any loss of data in the unlikely event that such losses should occur while using the product.
- Minimize the volume on your device before connecting the product.
- Do not subject the product to strong impact.
- Do not store the product in direct sunlight, near heating devices, or in hot, humid, or dusty places. Additionally, do not allow the product to get wet.
- When the product is used for a long time, the product may become discolored due to ultraviolet light (especially direct sunlight) and wear.
- Make sure to hold the plug when connecting and disconnecting the AC adapter. The cable may become severed or an accident may occur if you pull on the cable itself.
- Ensure the plug is fully inserted.
- If you use the product near an electronic device or transmitter (such as a mobile phone), unwanted noise may be heard. In this case, move the product away from the electronic device or transmitter.
- If you use the product near a radio antenna, noise may be seen or heard in the radio signal. In this case, move the product away from the radio antenna.
- Do not place items sensitive to magnetism (such as cash cards) near the product. Doing so may cause negative effects to those items.
- Do not place the product directly on delicate materials such as marble or unfinished wood.

Part names and functions

Left speaker

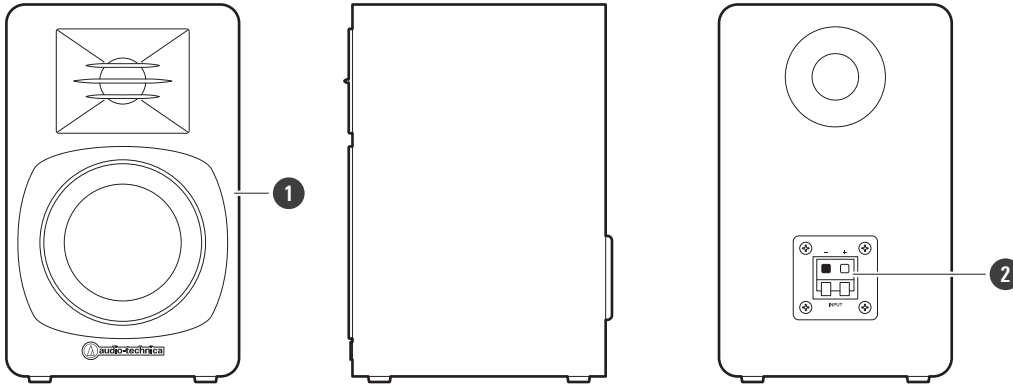

1 Speaker body

2 Speaker cable terminal

Used to connect the speakers (L/R) to each other.

Right speaker

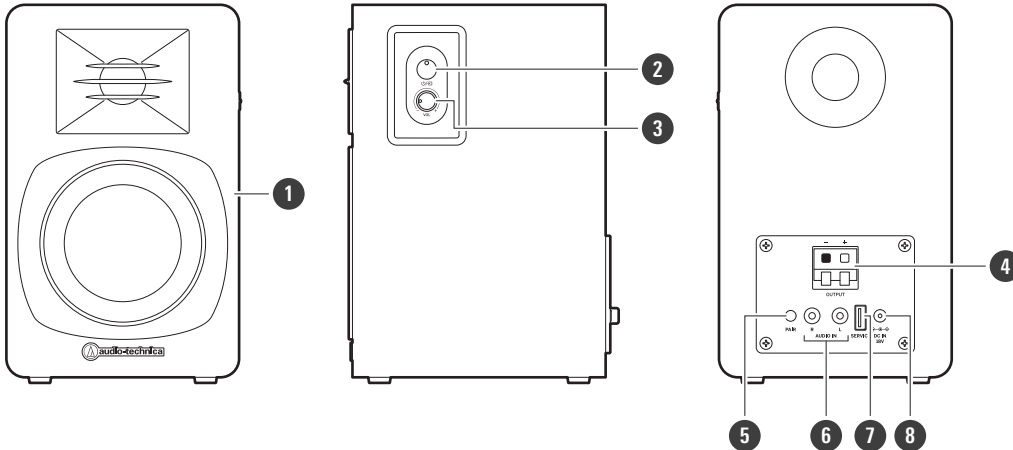

1 Speaker body

2 Power button / indicator lamp

Turns the product power on/off.

Displays the current mode (Bluetooth mode or wired mode) and Bluetooth connection status of the product.

3 Volume control knob

Adjusts the volume.

4 Speaker cable terminal

Used to connect the speakers (L/R) to each other.

5 Pairing button

Used to connect the product to Bluetooth devices.

Part names and functions

6 Audio input terminals

Used to connect a RCA audio cable. The red terminal connects the right channel, and the black terminal connects the left channel.

7 USB terminal (USB Type-A)

Used for updating the firmware. This terminal is not normally used. It also cannot be used for USB charging.

8 Power supply terminal

Used to connect the AC adapter.

Accessories

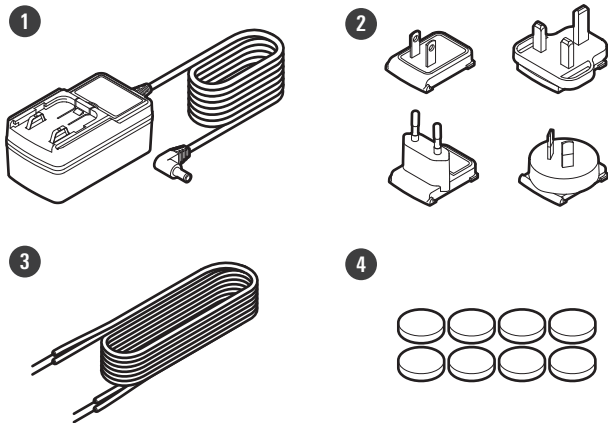

1 AC adapter

2 AC adapter replacement plug × 4

Attach the AC adapter replacement plug for the outlet you are using.

3 Speaker cable

Used to connect the speakers (L/R) to each other.

4 Rubber foot × 8

Getting ready to use the product

Attaching the rubber feet

Before setting up the product, be sure to attach the rubber feet to the bottom of the speakers.

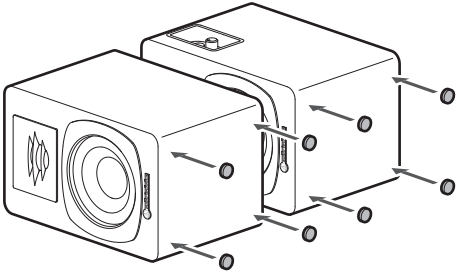

About installation of the speaker

- Be sure to install the product on a level surface.
- Install the product while paying close attention to the placement of the left and right speakers.

Connecting the speakers

Use the speaker cable to connect the speakers (L/R) to each other.

1 Press the tabs on the speaker cable terminals on the back of the speaker and insert the speaker cable.

- Connect the speakers (L/R) to each other by matching the polarity of the speaker cable terminals (red terminal = positive (+), black terminal = negative (-)).
- Be sure to connect the speaker cable terminals of the same color.

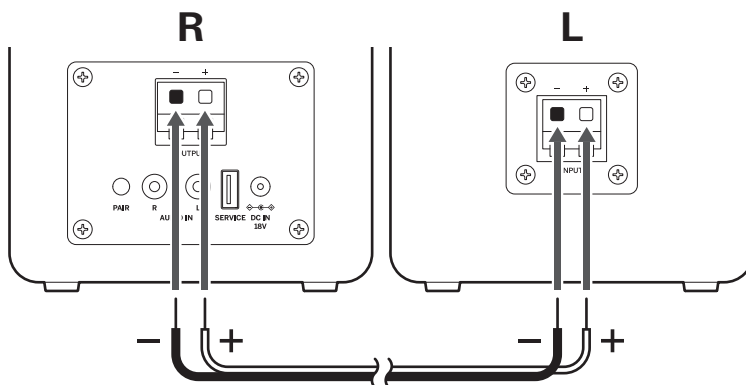

Attaching an AC adapter replacement plug to the AC adapter

Attach the AC adapter replacement plug for the outlet you are using to the AC adapter.

- 1** Select the plug that fits the outlet you are using.
- 2** Align the tabs on the underside of the plug with the recesses on the AC adapter, and slide the plug into the AC adapter until it clicks into place.

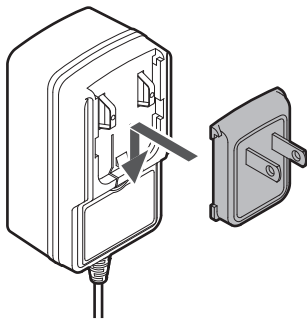

Removing the AC adapter replacement plug

- 1** Press and hold the PUSH button and slide the AC adapter replacement plug up to remove it.

Turning the power on/off

Turning on the product

- 1 Insert the plug of the AC adapter into the power supply terminal.

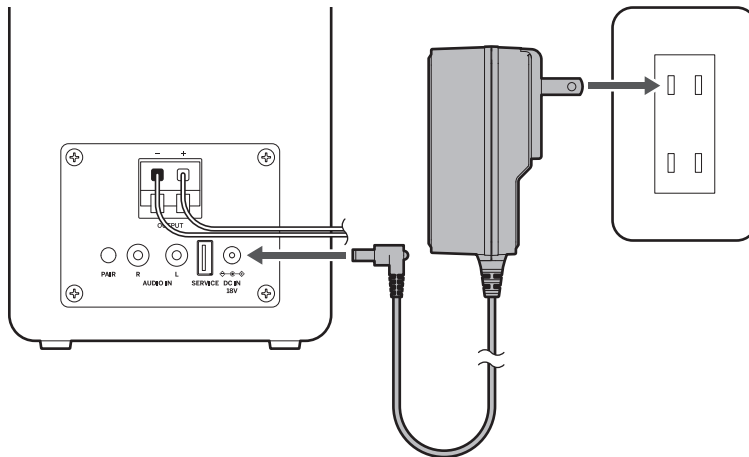

- 2 Plug the AC adapter into an outlet.

» The indicator lamp will light in red.

- 3 Press the power button.

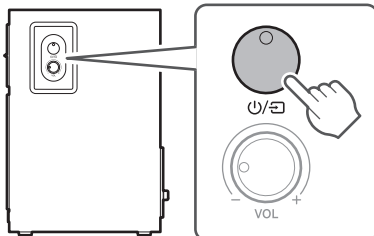

» The power turns on, and the indicator lamp lights up as follows.

Indicator lamp	Status
Lights solid green	Power on (Wired mode)
Lights solid blue	Power on (Bluetooth mode, Bluetooth device connected)
Flashes blue (fast)	Power on (Bluetooth mode, Bluetooth device not connected)
Flashes blue (slow)	Power on (Bluetooth mode, Bluetooth device connection standby)

Turning off the product

- 1 Press and hold the power button (for at least 3 seconds).

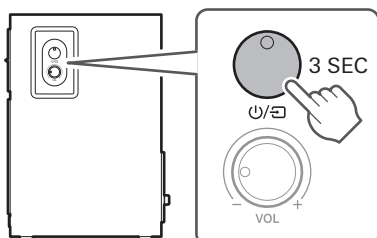

» The indicator lamp will light in red.

About wireless and wired connections

The product can be operated via a Bluetooth wireless connection or a wired connection, according to user's preference.

Wireless connection

To connect to the product wirelessly via Bluetooth, please see "Wireless use" (p. 11).

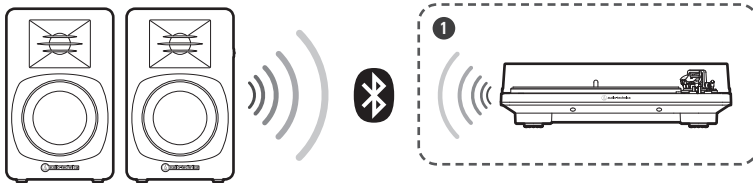

1 Bluetooth-capable turntable

Wired connection

To connect to the product using a RCA audio cable, please see "Wired use" (p. 14).

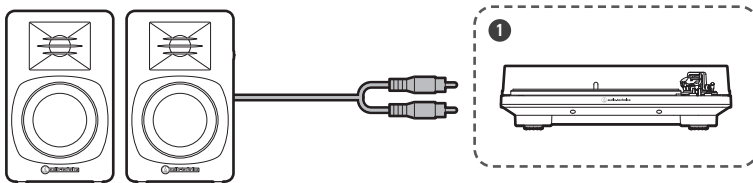

1 Turntable

Wireless use

The product supports Bluetooth connections. It can be used with smartphones, tablets, and other Bluetooth devices.

Pairing a Bluetooth device

- Read the user manual for the Bluetooth device.
- Place the Bluetooth device within 1 m (3.3') of the product to perform pairing correctly.
- Note that operation is not guaranteed with Bluetooth connections.

1 Press the power button to turn on the power.

2 Press the power button to enter Bluetooth mode (with the indicator lamp flashing blue).

- The product will switch between wired mode (with the indicator lamp lit in green) and Bluetooth mode (with the indicator lamp flashing blue) every time the power button is pressed.

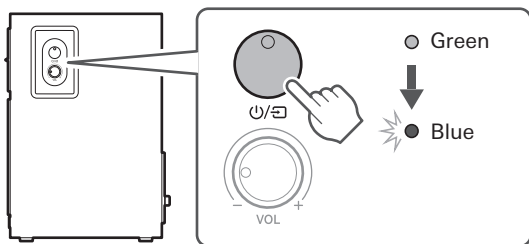

3 Press the pairing button.

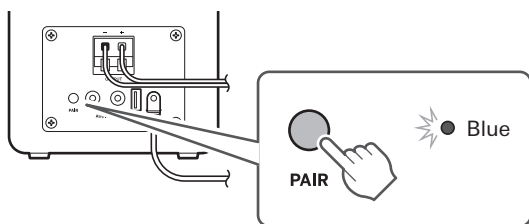

4 Use your Bluetooth device to begin the pairing process and search for the product. When your Bluetooth device finds the product, "AT-SP3X" will be displayed on the device.

- For information about using your Bluetooth device, refer to the device's user manual.

5 Select "AT-SP3X" and register it in the Bluetooth device that you will connect to.

- Some devices may ask for a passkey. In this case, enter "0000". The passkey may also be called a passcode, PIN code, PIN number, or password.

» **The indicator lamp will light in blue.**

About pairing

When connecting a new Bluetooth device, you need to pair it with the product. Once the Bluetooth device and the product are paired, you do not need to pair them again. The product supports multipairing, in which a connection history is saved. However, in the following cases you will need to pair again even if the Bluetooth device was paired once:

- If the product is deleted from the Bluetooth device's connection history.
- If the product is sent out for repair.
- If the product is reset.
- If the AC adapter is unplugged from the product.

Multipoint function

This product supports multipoint connectivity, which allows two Bluetooth devices to be connected simultaneously. However, not all Bluetooth device combinations are guaranteed as possible, and operation is not guaranteed when the product is connected to two devices.

Connecting using multipoint

1 Pair with the first Bluetooth device.

2 Press the pairing button.

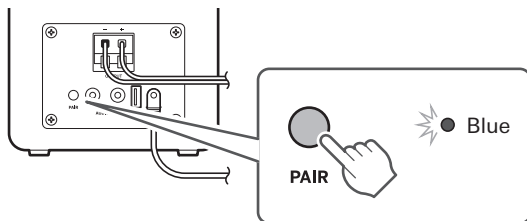

» The indicator lamp will flash in blue.

3 Pair with a second Bluetooth device.



- If a connection cannot be established, turn the product off and back on.
- Up to two Bluetooth devices can be connected using multipoint. To connect to a different Bluetooth device, unpair one of the first two connected devices.
- Music cannot be played from two devices at once.

Listening to music

- Make sure the volume of the product is turned all the way down before playing music from a connected Bluetooth device.

1 Press the power button to enter Bluetooth mode (with the indicator lamp lit in blue).

- The product will switch between wired mode (with the indicator lamp lit in green) and Bluetooth mode (with the indicator lamp lit in blue) every time the power button is pressed.
- If the indicator lamp is flashing blue quickly, no devices have been paired. A device must be paired before continuing.

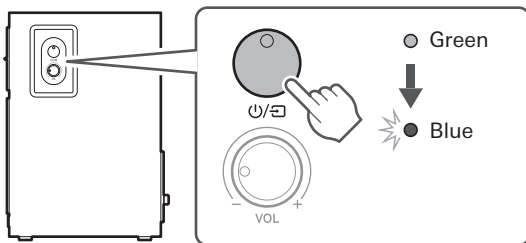

2 Start music playback on the Bluetooth device.

3 Turn the volume control knob to adjust the volume.

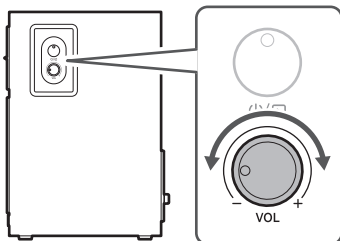

- If the indicator lamp is flashing blue slowly, the product is trying to connect to a different Bluetooth device but the target Bluetooth device cannot be found. Make sure the Bluetooth function of the target Bluetooth device is turned on. To connect a different Bluetooth device, perform pairing again.

Wired use

The product can be connected to turntables or other audio equipment using wired connection.

Connecting audio device

Connect a commercially available RCA audio cable to the audio input terminal of the product. Be sure to match the color of the RCA audio cable plugs with the color of the audio input terminals.

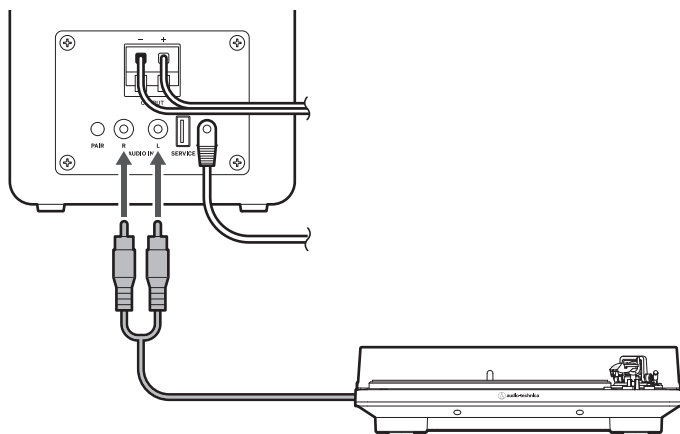

Listening to music

- Make sure the volume of the product is turned all the way down before playing music from a connected audio device.

1 Press the power button to enter wired mode (with the indicator lamp lit in green).

- The product will switch between wired mode (with the indicator lamp lit in green) and Bluetooth mode (with the indicator lamp flashing/lit in blue) every time the power button is pressed.

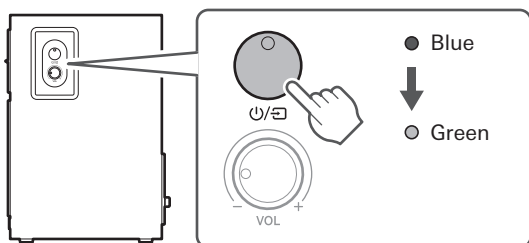

2 Start music playback on the audio device.

3 Turn the volume control knob to adjust the volume.

Wired use

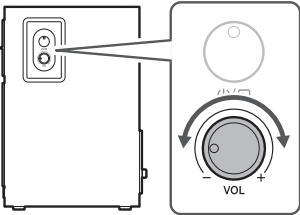

Cleaning

Get into the habit of regularly cleaning the product to ensure that it will last for a long time. Do not use alcohol, paint thinners, or other solvents for cleaning purposes.

- Use a dry cloth to clean the product.
- Wipe away any perspiration or dirt from the cable with a dry cloth immediately after use. Failure to clean the cable may cause it to deteriorate and harden over time, resulting in malfunction.
- Wipe the cable's plug with a dry cloth if dirty.



- Do not touch the driver unit.
- For long-term storage, keep the product in a well-ventilated place without high temperatures and humidity.

Troubleshooting

Unable to pair (Bluetooth mode)

- Confirm that the Bluetooth device communicates using Ver. 2.1+EDR or higher.
- Place the product and the Bluetooth device within 1 m (3.3') of each other.
- Remove the pairing information for the Bluetooth device then pair the product with this device again.

No sound is heard / Sound is faint (Bluetooth mode)

- Turn on the power of the product and the Bluetooth device.
- Turn up the volume on the product and the Bluetooth device.
- Move away from obstacles between the product and the Bluetooth device, such as people, metal, or walls, and place the product and device closer together.

Sound is distorted / Noise is heard / Sound cuts out (Bluetooth mode)

- Turn down the volume on the product and the Bluetooth device.
- Keep the product away from devices that emit radio waves such as microwaves and wireless routers.
- Keep the product away from TVs, radios, and devices with built-in tuners. These devices can also be affected by the product.
- Remove obstacles between the product and the Bluetooth device and place them closer together.



- For details about how to operate your Bluetooth device, refer to the device's user manual.

Dimensions

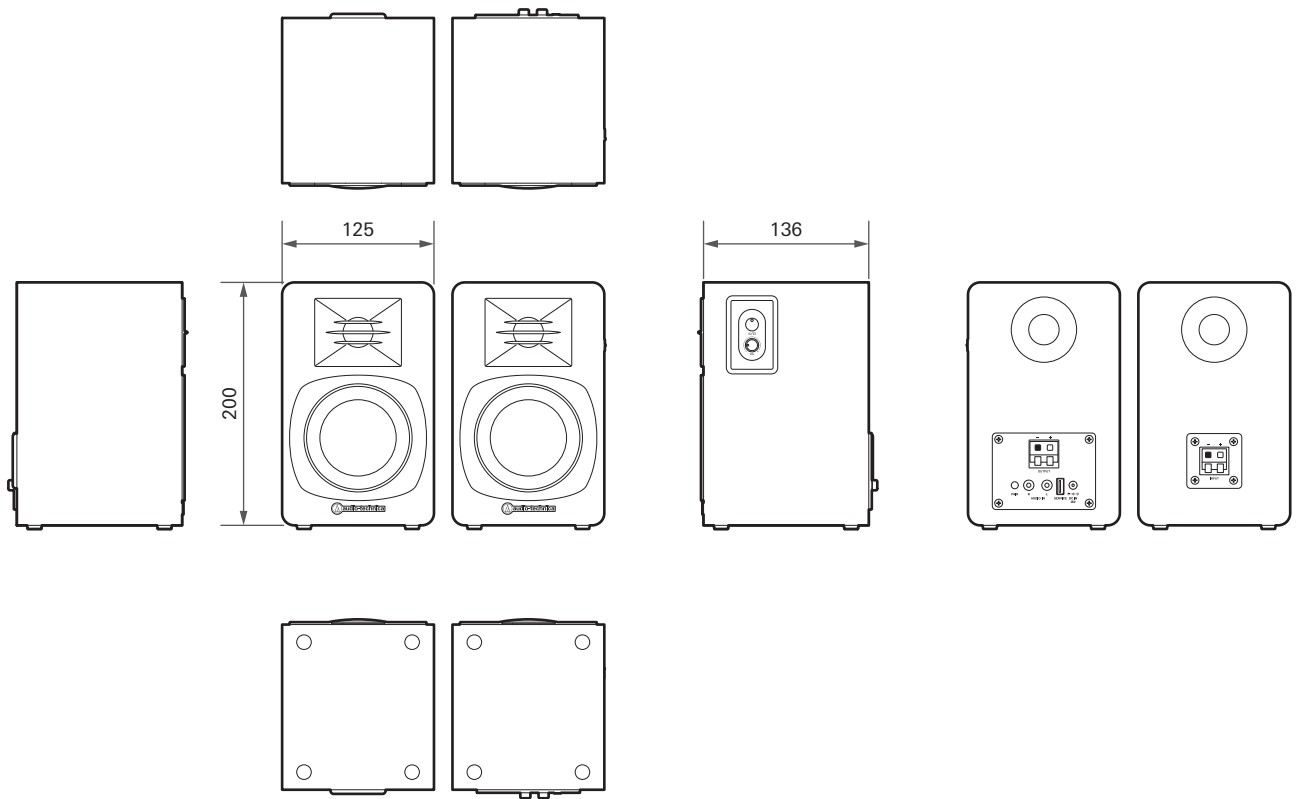

(Unit: mm)

Specifications

Speakers

Speaker unit	76 mm (3.0") × 2
Tweeter unit	27 mm (1.1") × 2
Frequency response	55 to 20,000 Hz
Maximum output	30 W

Communication specifications

Communication system	Bluetooth version 5.3
Maximum RF output	10 mW EIRP
Maximum communication range	Line of sight - approx. 10 m (33')
Frequency band	2.402 GHz to 2.480 GHz
Modulation method	GFSK, Pi/4DQPSK, 8DPSK
Spread spectrum method	FHSS
Compatible Bluetooth profile	A2DP
Supported codec	SBC
Supported content protection method	SCMS-T
Supported sample rate	44.1 kHz, 48 kHz
Supported bit depth	16 bits, 24 bits
Transmission band	20 to 20,000 Hz

Other

Input jack	Analog audio input terminals (RCA pin plug × 2)
Speaker cable length	2.0 m (6.6')
AC adapter cable length	1.2 m (3.9')
Power supply	100 to 240 V AC / 18 V DC (using included AC adapter)
Dimensions (excluding protrusions)	200 mm (7.9") × 125 mm (4.9") × 136 mm (5.4") (H × W × D)
Weight	Left side: Approx. 1.5 kg (3.3 lbs), Right side: Approx. 1.6 kg (3.5 lbs)
Operating temperature	5°C to 40°C (41°F to 104°F)
Accessories	AC adapter, AC adapter replacement plug × 4, speaker cable (for connecting left and right), rubber foot × 8
Sold separately	AC adapter, AC adapter replacement plug × 4, speaker cable (for connecting left and right), rubber foot × 8

Specifications

- For product improvement, the product is subject to modification without notice.

Trademarks

- The **Bluetooth**[®] word mark and logos are registered trademarks owned by Bluetooth SIG, Inc., and any use of such marks by Audio-Technica Corporation is under license. Other trademarks and trade names are those of their respective owners.

株式会社オーディオテクニカ

〒194-8666 東京都町田市西成瀬2-46-1
www.audio-technica.co.jp

Audio-Technica Corporation

2-46-1 Nishi-naruse, Machida, Tokyo 194-8666, Japan
www.audio-technica.com
©2024 Audio-Technica Corporation
Global Support Contact: www.at-globalsupport.com