



## SPORT True Wireless

True Wireless stereo earbuds

Model: CX200TW1, CX200TW1 R, CX200TW1 L, CX200TW1 C



### Instruction manual

Use the search function, the navigation (left) or the following links:

Start

“Product overview”

“Getting started”

“Using the earbuds”

“FAQ/If a problem occurs ...”

“Specifications”

**Sonova Consumer Hearing GmbH**

Am Labor 1

30900 Wedemark

Germany



[www.sennheiser-hearing.com](http://www.sennheiser-hearing.com)

Version: 05/22 A01

## Important safety instructions

- ▷ Read this instruction manual carefully and completely before using the product.
- ▷ Always include this instruction manual when passing the product on to third parties.
- ▷ Do not use the product if it is obviously defective or makes loud, unusual (whistling or beeping) noise.
- ▷ Only use the product in environments where **Bluetooth®** wireless transmission is permitted.

### Preventing damage to health and accidents

- ▷ Protect your hearing from high volume levels. Permanent hearing damage may occur when headphones are used at high volume levels for long periods of time. Headphones of the Sennheiser brand sound exceptionally good even at low and medium volume levels. 
- ▷ Do not insert the earphones too deep into your ears and never insert them without ear adapters. Always remove the earphones slowly and carefully from your ears.
- ▷ The product generates stronger permanent magnetic fields that could cause interference with cardiac pacemakers, implanted defibrillators (ICDs) and other implants. Always maintain a distance of at least 3.94"/10 cm between the product component containing the magnet (earbuds and charging case) and the cardiac pacemaker, implanted defibrillator, or other implant. 
- ▷ Keep the product, accessories and packaging parts out of reach of children and pets to prevent accidents. Swallowing and choking hazard.
- ▷ Do not use the product in an environment that requires your special attention (e.g. in traffic).

### Preventing damage to the product and malfunctions

- ▷ Always keep the product dry and do not expose it to extreme temperatures (hairdryer, heater, extended exposure to sunlight, etc.) to avoid corrosion or deformation. The normal operating temperature is from 0 °C to 40 °C/32 °F to 104 °F.
- ▷ Use only attachments/accessories/spare parts supplied or recommended by Sonova Consumer Hearing.
- ▷ Clean the product only with a soft, dry cloth. Product parts with ingress protection (IP protection rating) can be cleaned with a slightly damp cloth.









### Safety instructions for Lithium rechargeable batteries



#### WARNING

If abused or misused, rechargeable batteries may leak. In extreme cases, they may even present a risk of:

- explosion
- heat and fire development
- smoke and/or gas development
- damage to health and/or the environment

	Only use rechargeable batteries and chargers recommended by Sonova Consumer Hearing.
	Do not leave the product / rechargeable batteries unattended while charging.
	Only charge the product / rechargeable batteries at ambient temperatures between 10 °C and 40 °C/50 °F and 104 °F and do not charge them near easily flammable objects.
	Do not heat the product / rechargeable batteries above 70 °C/158 °F. Avoid exposure to sunlight and do not throw the product / rechargeable batteries into fire.
	Switch rechargeable battery-powered products off after use.
	When not using the product / rechargeable batteries for extended periods of time, charge them regularly (about every three months).
	This product contains coin rechargeable batteries. If you think the product / a coin rechargeable battery has been swallowed or is lodged in the body, seek medical assistance immediately.
	Avoid prolonged skin contact with the product, rechargeable battery, charger or charging cable when connected to a power source. These components can heat up during charging and cause skin irritation.
	Dispose of defective products with built-in rechargeable batteries at special collection points or return them to your specialist dealer to facilitate recycling.

**Notes on the ingress protection rating of the earbuds**

The earbuds feature an IP54 ingress protection rating which means they are protected from the ingress of dust and water (according to the International Protection Rating (IP code), IEC standard 60529, tested under laboratory conditions).

The earbuds can be used at the beach in sandy/dusty conditions and in rain, for example. However, they are not suitable for immersion in water or for wearing in the shower. In case of permanent moisture/wetness, the ingress protection can be reduced and the product can be damaged.

Do not charge wet earbuds. Completely dry wet earbuds with a dry cloth before charging them.

The charging case is not splash waterproof. Always keep the charging case dry.

**Notes on data collection and processing and on firmware updates**

This product stores individual settings such as the volume and the Bluetooth addresses of paired devices. This data is required for the operation of the product and is not transferred to Sonova Consumer Hearing GmbH or companies commissioned by Sonova Consumer Hearing GmbH and is not processed.

## Important safety instructions

Using the “Sennheiser Smart Control” app, you can update the firmware of the product for free via an Internet connection. If the device on which the app is installed is connected to the Internet, the following data is automatically transferred to and processed by Sonova Consumer Hearing servers in order to provide and transfer suitable firmware updates: hardware identifier, hardware revision number, firmware version of the product, operating system type (Android, iOS) and version, version of the app. The data is only used for the purpose of providing and transferring the firmware updates and is not stored permanently.

If you do not want this data to be transferred and processed, do not connect to the Internet.

### Intended use/Liability

These headphones have been designed as an accessory for Bluetooth compliant devices. They are intended for wireless audio communication such as music playback and phone calls via Bluetooth wireless technology.

It is considered improper use when the product is used for any application not named in the corresponding product documentation.

Sonova Consumer Hearing GmbH does not accept liability for damage arising from misuse or improper use of this product and its attachments/accessories.

Sonova Consumer Hearing GmbH is not liable for damages to USB devices that are not consistent with the USB specifications. Sonova Consumer Hearing GmbH is not liable for damages resulting from the loss of connection due to flat or overaged rechargeable batteries or exceeding the Bluetooth transmission range.

Before putting into operation, please observe the respective country-specific regulations.

## Package contents

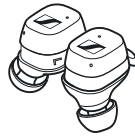

Earbud R for right ear (model: CX200TW1 R) and earbud L for left ear (model: CX200TW1 L)



Charging case (model: CX200TW1 C) with built-in rechargeable battery for the earbuds with lanyard



USB charging cable with USB-C and USB-A connector, length approx. 0.25 m



Silicone ear fins (size N, S1, S2 (pre-mounted to the earbuds) and S3)



Closed silicone ear adapters (size S, M and L) with black cross inside, for the use of “Focus” mode



Open silicone ear adapters (size S, M (pre-mounted to the earbuds) and L) with blue marking inside, for the use of “Aware” mode



Quick guide



Safety guide

Online you can find:

- this detailed instruction manual and additional information ([www.sennheiser-hearing.com/download](http://www.sennheiser-hearing.com/download))
- the Sennheiser Smart Control app for configuring the headphones and for additional functions ([www.sennheiser-hearing.com/smartcontrol](http://www.sennheiser-hearing.com/smartcontrol))
- a list of accessories on the SPORT True Wireless product page at [www.sennheiser-hearing.com/sport-true-wireless](http://www.sennheiser-hearing.com/sport-true-wireless) (to purchase online or contact your local Sonova Consumer Hearing partner: [www.sennheiser-hearing.com/service-support](http://www.sennheiser-hearing.com/service-support))

# Product overview

## Charging case

Model: CX200TW1 C

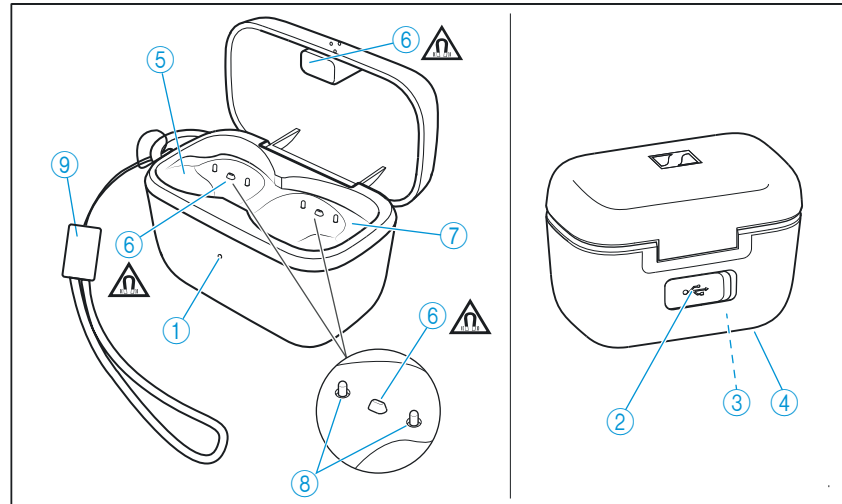

- ① LED displays the charging process/charge status of the rechargeable battery of the charging case or of the earbuds (when inserted into the charging case)
- ② Input for USB-C connector with protective cover for charging the rechargeable batteries
- ③ Built-in rechargeable battery for charging the earbuds on the go
- ④ Type plate
- ⑤ Charging compartment for the left earbud **L**
- ⑥ Magnetic holders
- ⑦ Charging compartment for the right earbud **R**
- ⑧ Charging contacts
- ⑨ Lanyard

# Earbuds

Model: CX200TW1 R and CX200TW1 L

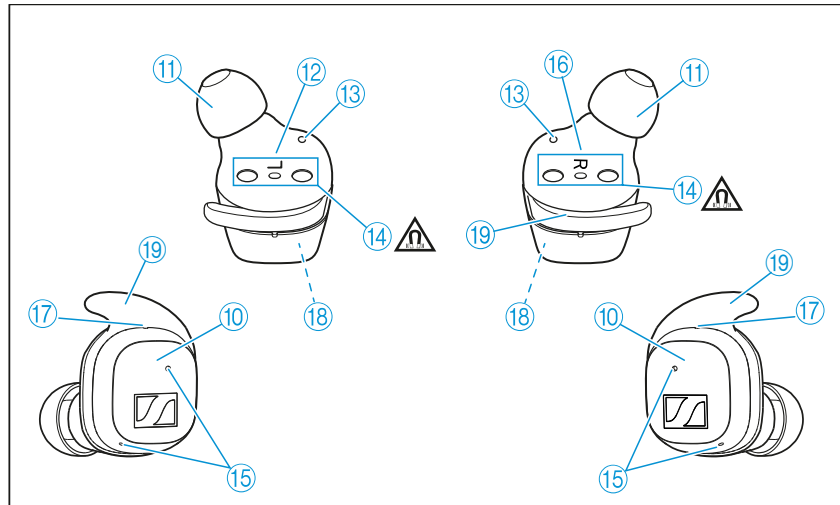

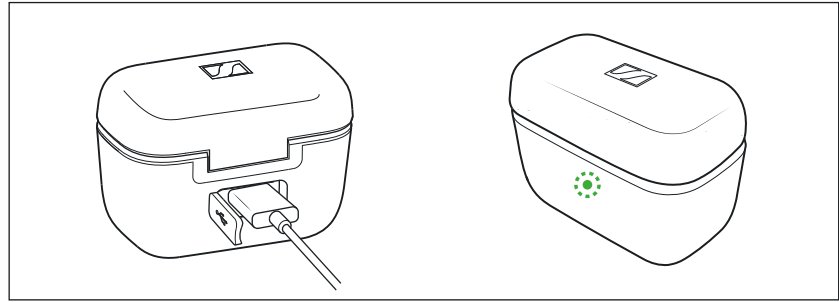

- ⑩ Touch control panel
- ⑪ Changeable silicone ear adapters
- ⑫ Left earbud **L**
- ⑬ Status LED (only visible when lit)
- ⑭ Charging contacts with magnetic holders
- ⑮ Microphones for phone calls
- ⑯ Right earbud **R**
- ⑰ Openings for acoustic optimization
- ⑱ Built-in rechargeable battery
- ⑲ Changeable ear fins for a fully customizable secure fit

## Overview of the LED indications of the charging case





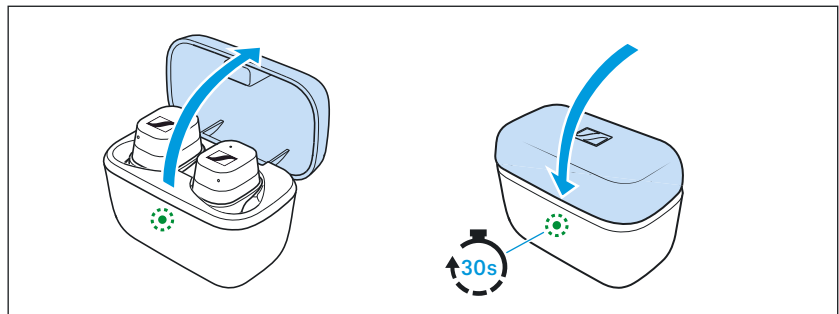

When a USB cable is connected, the LED of the charging case permanently displays the charging process:

LED		Charging case WITH earbuds inserted	Charging case WITHOUT earbuds inserted
	pulses yellow	... earbuds and charging case are being charged	... charging case is being charged
	lights up green	... earbuds and charging case are fully charged	... charging case is fully charged
	flashes red	... charging error/ battery error (> 34)	... charging error/ battery error (> 34)



If you open the lid of the charging case and no USB cable is connected, the LED of the charging case displays the battery charge status or the charging process of the earbuds. If you close the lid of the charging case, the LED will go off after approx. 30 seconds.









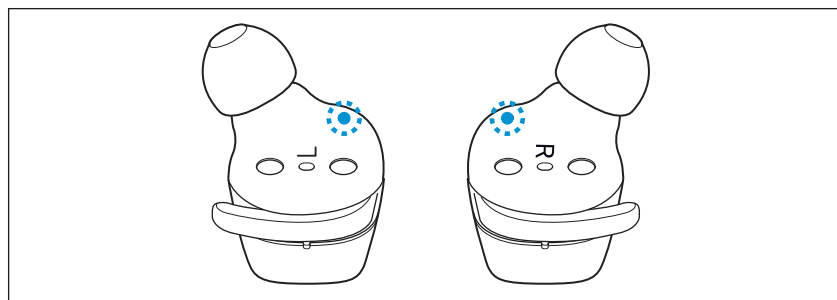

LED		Charging case WITH earbuds inserted	Charging case WITHOUT earbuds inserted
	lights up green	... earbuds are fully charged and the charging case can still charge at least one complete cycle	... charging case is fully charged
	pulses yellow	... earbuds are being charged via the rechargeable battery of the charging case	–
	lights up yellow	... earbuds are fully charged, the charging case cannot charge another complete cycle	... charging case is charged less than 90 %
	lights up red	... rechargeable batteries of the earbuds and the charging case are almost empty	... rechargeable battery of the charging case is almost empty
	flashes red	... charging error/ battery error (> 34)	... charging error/ battery error (> 34)

- i** If the LED does not light up:
- Clean the contacts on the earbuds and in the charging case (> 33).
  - Charge the rechargeable batteries of the earbuds and the charging case until the LED lights up again (> 14).

**i** If you close the lid of the charging case, the LED will go off after approx. 5 minutes.

## Overview of the LED indications of the earbuds



LED		Meaning; the earbuds...
	flashes red-blue for approx. 1 minute	... are in Bluetooth pairing mode
	flashes blue 3x	... Bluetooth pairing or earbud pairing successful
	flashes red 3x	... Bluetooth pairing or earbud pairing failed
	lights up blue	... are connected to a device via Bluetooth
	lights up red	... are not connected to a device via Bluetooth or the connection has been lost
	flashes red quickly	... rechargeable battery is almost empty
	flashes red slowly	... system error – perform a reset (> 35)
	flashes red-green for approx. 1 minute	... are in earbud pairing mode (to pair the right and the left earbud) (> 18)

## Notes on voice prompts

The earbuds output voice prompts for events (the table gives some examples). Using the Smart Control app, you can change the language of the voice prompts, choose between voice prompts and beep sounds, or deactivate the status messages with a few exceptions (e.g. rechargeable battery is empty).

Voice prompt	Meaning/earbuds...
“Power on”	... are switched on
“Power off”	... switch off
“Connected”	... connected via Bluetooth
“No connection”	... not connected via Bluetooth
“Pairing”	... in Bluetooth pairing mode
“Pairing successful”	... Bluetooth pairing successful
“Pairing failed”	... Bluetooth pairing not successful
“Recharge headset”	... Rechargeable battery is almost empty. Recharge the rechargeable battery.
“Call rejected”	... incoming call rejected
“Call ended”	... call ended

# Getting started

## 1. Waking up the earbuds and the charging case and charging the rechargeable batteries

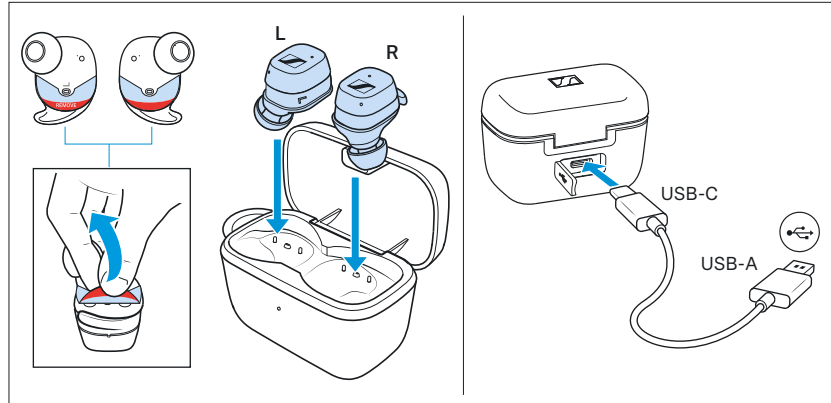

Upon delivery, the rechargeable batteries of the earbuds and the charging case are in sleep mode and have to be woken up by connecting them to a power source once.

- ▷ Remove the protective foils from the earbuds.
- ▷ Insert the earbuds into the charging case.
- ▷ Close the lid of the charging case.
- ▷ Open the protective cover of the USB socket of the charging box. Connect the USB-C cable to the charging case and to a USB power source (> 14).  
The earbuds and the charging case are woken up and the rechargeable batteries are being charged. The earbuds are now ready for use.

## 2. Selecting “Adaptable Acoustics” with suitable ear adapters and ear fins for optimum fit of the earbuds

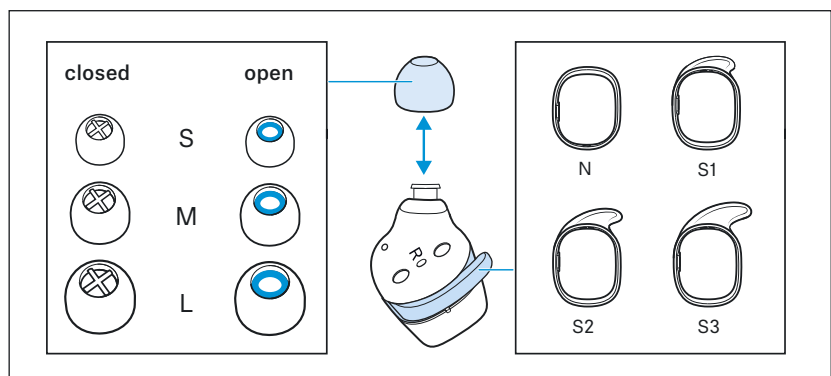

The perceived sound quality including bass performance for the “Adaptable Acoustics” feature of the SPORT True Wireless depends to a large extent on the correct fit of the earbuds in the ear. Earbuds that fit perfectly in your ears do not fall out even during fast movements and, especially for “Focus” mode, the best possible noise cancellation is ensured. Therefore, you can choose between ear adapters and ear fins in different sizes.

### Open ear adapters for “Aware” mode

Use the open ear adapters (with blue marking inside) for “Aware” mode, for example to reduce body borne noise when running (breathing, footsteps, clothes rattling) and to be more aware of high sounds from your surroundings (car horn, bike bell, barking dog).

### Closed ear adapters for “Focus” mode

Use the closed ear adapters (with a black cross inside) for “Focus” mode to minimize your awareness of your surroundings and to fully immerse yourself in your favorite music, for example, when working out at the gym or at home.

Proceed as follows:

- ▷ Test which ear adapter size is best for “Aware” or “Focus” mode and which ear fins give you the best sound quality and the best wearing comfort.
- ▷ You can choose between open and closed ear adapters in size S, M and L (> 21) and 4 different ear fins in size N, S1, S2 and S3 (> 21). You may need different ear adapter sizes for your right or left ear.
- ▷ In the Smart Control app, select the suitable mode for the open or closed ear adapters used under “Adaptable Acoustics”, (> 23).

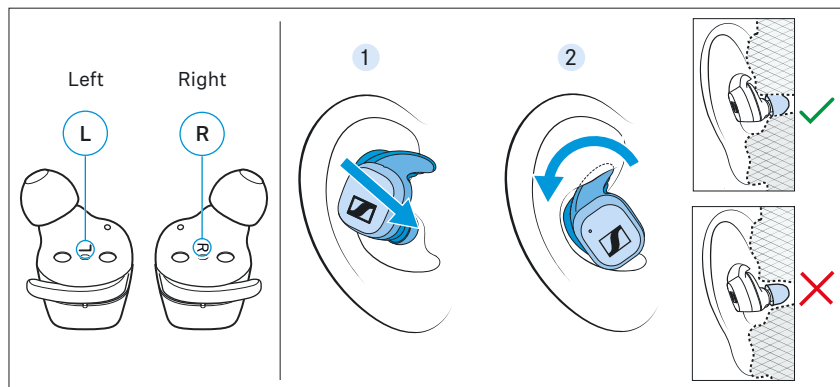

- ▷ Assign the right earbud to your right ear and the left earbud to your left ear.
- ▷ Insert the earbuds at a slight angle into the ears and twist them slightly into the ear canal so that they sit comfortably and snugly in the ear canal.

## 3. Connecting the earbuds to a Bluetooth device

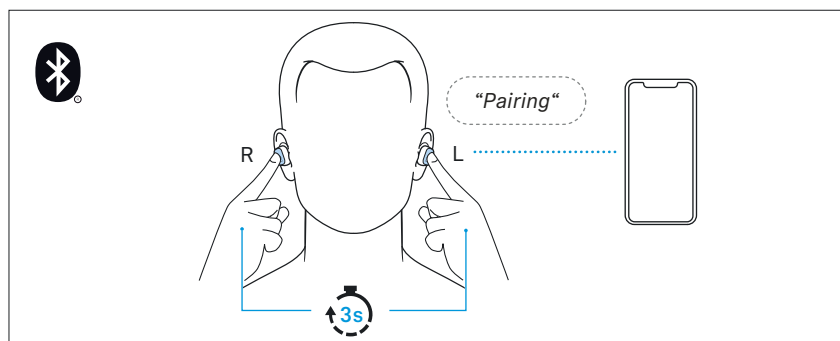

Connect the earbuds to your smartphone via Bluetooth (> 17).

## 4. Installing the Smart Control app on your smartphone

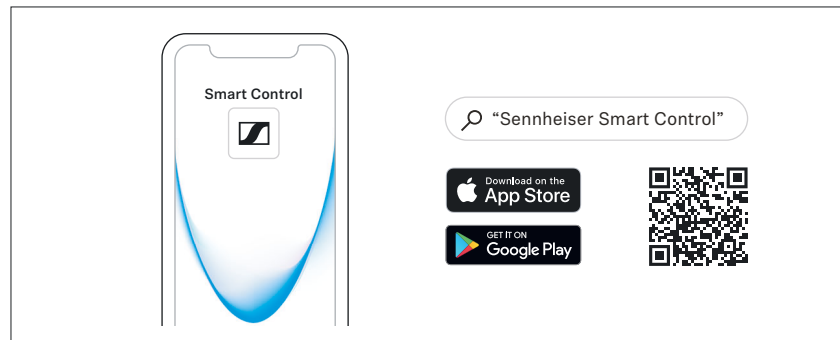

The Sennheiser **Smart Control** app allows you to use all functions and settings of the earbuds, to set the “Adaptable Acoustics” feature to match the ear adapters used (open or closed) and to e.g. adjust the sound to your liking using the equalizer (> 20).

## Using the earbuds

### Information on the rechargeable battery, the charging process and the first use

The earbuds and the charging case each have a built-in rechargeable battery. The charging case allows you to store the earbuds safely at all times while on the go, and they are being charged at the same time.

Upon delivery, the rechargeable batteries of the earbuds and the charging case are in sleep mode. Remove the protective foil on the charging contacts of the earbuds and connect the charging case to a USB power source to exit sleep mode.

A complete charging cycle of the charging case and the earbuds takes about 1.5 hours. The quick charge function gives you approx. 1 hour of playback time after 10 minutes of charging. The charging time can vary depending on the power source used and the ambient temperature.

We recommend charging the earbuds and the charging case for a complete charging cycle without interruption before using for the first time.

We recommend using the supplied USB cable and a compatible standard USB power supply for charging the headphones.

When a USB cable connected to a power source is also connected to the charging case, the rechargeable battery of the charging case is being charged. When the earbuds are inserted into the charging case, their rechargeable batteries are being charged at the same time. The LED of the charging case displays the charge status (> 8).

When the battery charge of the earbuds drops to a critical level, a voice prompt asks you to recharge the earbuds (“Recharge headset”).

The charge status of the rechargeable battery of the charging case is displayed by the LED on the charging case (> 8).

At the end of its operational lifetime, this product with its built-in rechargeable battery must be disposed of separately from normal household waste. You can find more information here: > 39.

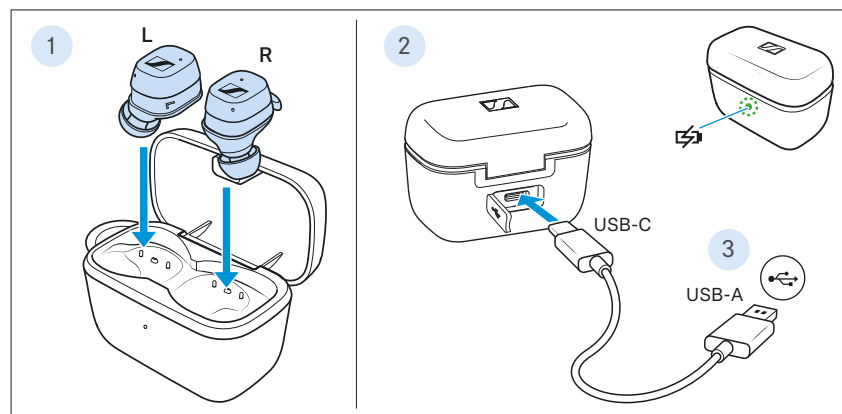

### Charging the rechargeable batteries of the earbuds and the charging case



1. Open the charging case by overcoming a slight magnetic resistance and insert the left earbud into the left charging compartment and the right earbud into the right charging compartment. The earbuds are magnetically pulled into the charging compartments.
2. Open the protective cover of the USB socket of the charging box. Connect the USB-C connector of the USB cable to the USB-C socket of the charging case.
3. Connect the USB-A connector to a corresponding socket of a USB power source (to be ordered separately). Make sure that the USB power source is connected to the power supply system. The rechargeable batteries of the earbuds and the charging case are being charged.

If no earbuds are inserted into the charging case, only the rechargeable battery of the charging case is being charged.

The LED of the charging case displays the charge status:

LED		Charging case WITH earbuds inserted	Charging case WITHOUT earbuds inserted
	pulses yellow	... earbuds and charging case are being charged	... charging case is being charged
	lights up green	... earbuds and charging case are fully charged	... charging case is fully charged
	flashes red	... charging error/ battery error (> 34)	... charging error/ battery error (> 34)

**i** If the LED does not light up:

- Clean the contacts on the earbuds and in the charging case (> 33).
- Clean the USB-C socket of the charging case.
- Charge the rechargeable batteries of the earbuds and the charging case (at least 30 minutes) until the LED lights up again.

## Connecting the earbuds to a Bluetooth device

To be able to use the Bluetooth wireless connection, you must register both devices (earbuds and e.g. smartphone) via the device settings of your smartphone. This process is called pairing.

If operation differs from the steps mentioned, also refer to the instruction manual of the Bluetooth device you are using.

**i** When you switch on the earbuds for the first time after initial charging, they automatically switch to Bluetooth pairing mode.

## Information on the Bluetooth wireless connection

The earbuds are compatible with Bluetooth 5.2.

If your audio source supports one of the following high-resolution audio encoding methods, music is automatically played in high audio quality: aptX® or AAC. Otherwise the headphones will play your music in normal audio quality (SBC).

Paired devices establish the Bluetooth wireless connection immediately after switch-on and are ready for use.

When you switch on the earbuds, they automatically try to connect to the last connected Bluetooth device. The earbuds can save the connection profiles of up to eight Bluetooth devices with which they have been paired. Audio playback is only possible from one device at a time.

If you pair the earbuds with the ninth Bluetooth device, the saved connection profile of the least used Bluetooth device will be overwritten. If you want to re-establish a connection with the overwritten Bluetooth device, you have to pair the earbuds again.

Using the Smart Control app, you can view the list of paired devices and selectively connect and disconnect devices (“Connections”; > 17).

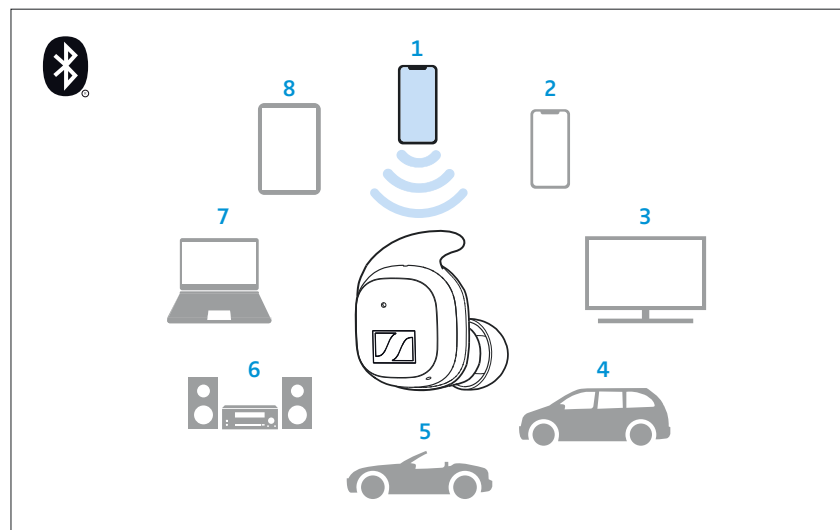

Paired and connected Bluetooth device



Paired Bluetooth device (currently not connected)



The right and the left earbud also use a Bluetooth wireless connection. Both earbuds are paired with each other upon delivery. If you are using a different earbud (e.g. a spare earbud), the two earbuds must also be paired with each other (> 18).



## Pairing the earbuds with a Bluetooth device

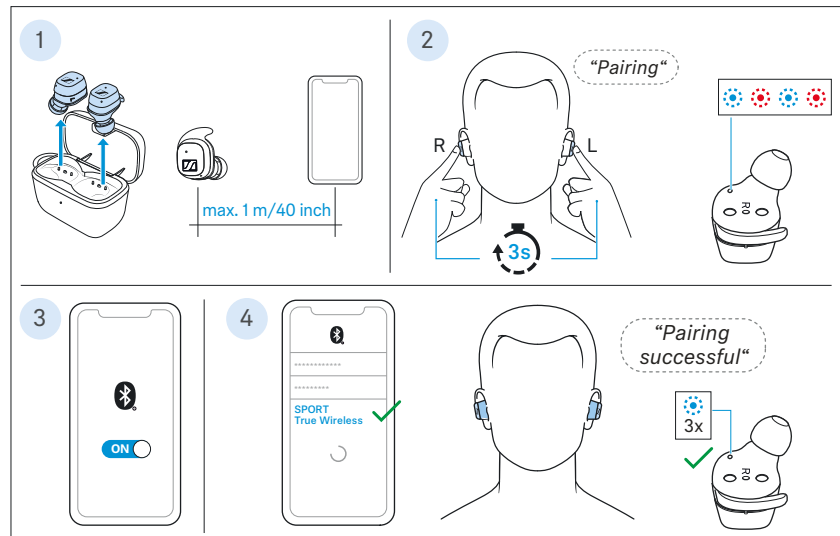

1. Take both earbuds out of the charging case and insert them into your ears (> 23). The distance between the earbuds and the Bluetooth device should not exceed 40"/1 m.
2. Simultaneously touch and hold the right and the left touch control panel for 3 seconds until you hear the voice prompt "Pairing" and a beep.  
The LEDs of the earbuds flash blue and red. The earbuds are in pairing mode.
3. Activate Bluetooth on your Bluetooth device.
4. Via the menu of your Bluetooth device, start the search for new Bluetooth devices.  
All active Bluetooth devices in the proximity of your smartphone are displayed.  
From the list of found Bluetooth devices, select "SPORT True Wireless". If necessary, enter the default pin code "0000".  
If pairing was successful, you hear the voice prompt "Pairing successful" and the LEDs of the earbuds flash blue 3x.

**i** The Bluetooth device name "SPORT True Wireless" can be changed individually using the Smart Control app.

**i** If no connection is established within 1 minute, pairing mode is terminated and the earbuds switch to idle mode. If necessary, repeat the steps described above.

If the earbuds are not paired with any Bluetooth device (the pairing list is empty), pairing mode is permanently active.

## Switching the connection to paired Bluetooth devices/"Connections"

To selectively switch the audio connection to paired Bluetooth devices using the "Connections" function, you require the Smart Control app (> 20).

- ▷ In the Smart Control app, tap “Connections”.  
The list of Bluetooth devices paired with the earbuds appears.
- ▷ From the list, select the paired device to which you want to connect the earbuds. Make sure that the desired device is switched on and Bluetooth is activated.  
The Bluetooth audio connection between the desired Bluetooth device and the earbuds is established.  
The app connection between the device with the Smart Control app installed and the earbuds remains active (only Bluetooth Low Energy for communication between app and earbuds, the device name is highlighted in bold).

**i** Using the “Connections” function, you can also selectively delete pairing information of devices without resetting the earbuds to the factory default settings.

## Disconnecting the earbuds from a Bluetooth device

- ▷ Via the menu of your Bluetooth device, disconnect the connection to the earbuds.  
The earbuds are disconnected from the Bluetooth device. The earbuds then search for other paired devices. If no device is found, you hear the voice prompt “No connection”. The headphones switch to idle mode.

**i** Using the “Connections” function in the Smart Control app, you can also selectively connect the earbuds to paired devices without terminating an existing connection or deleting the pairing information of certain devices (> 17).

**i** If you want to clear the Bluetooth pairing list of the earbuds, use the Smart Control app or reset the earbuds to the factory default settings (> 35).

## Pairing the earbuds with each other (optional)/restoring the factory default settings

The right and the left earbud are paired with each other upon delivery. If, however, you are using a different earbud (e.g. a spare earbud), you have to pair the two earbuds with each other once. This pairing process resets the earbuds to the factory default settings.

1. Make sure that the earbuds are not connected to any Bluetooth device. Deactivate Bluetooth on your Bluetooth device or delete “SPORT True Wireless” from the list of paired devices in the Bluetooth menu of your Bluetooth device.
2. Charge the right and the left earbud (> 14).
3. Take one earbud out of the charging case.  
The LED of the earbud lights up red.

4. Touch and hold the touch control panel for 10 seconds until you hear the voice prompt “Pairing” and a beep.  
The LED of the earbud flashes green and red. The earbud is in earbud pairing mode.
  5. Now take the second earbud out of the charging case and make sure that the right and the left earbud are close to each other (max. distance 50 cm).
  6. Touch and hold the touch control panel of the second earbud for 10 seconds until you hear the voice prompt “Pairing” and a beep.  
If pairing was successful, you hear the voice prompt “Pairing successful” and the LEDs of the earbuds flash blue 3x. The earbuds are paired with each other and the factory default settings are restored.
- ▷ Now pair the earbuds with your Bluetooth device (> 17).

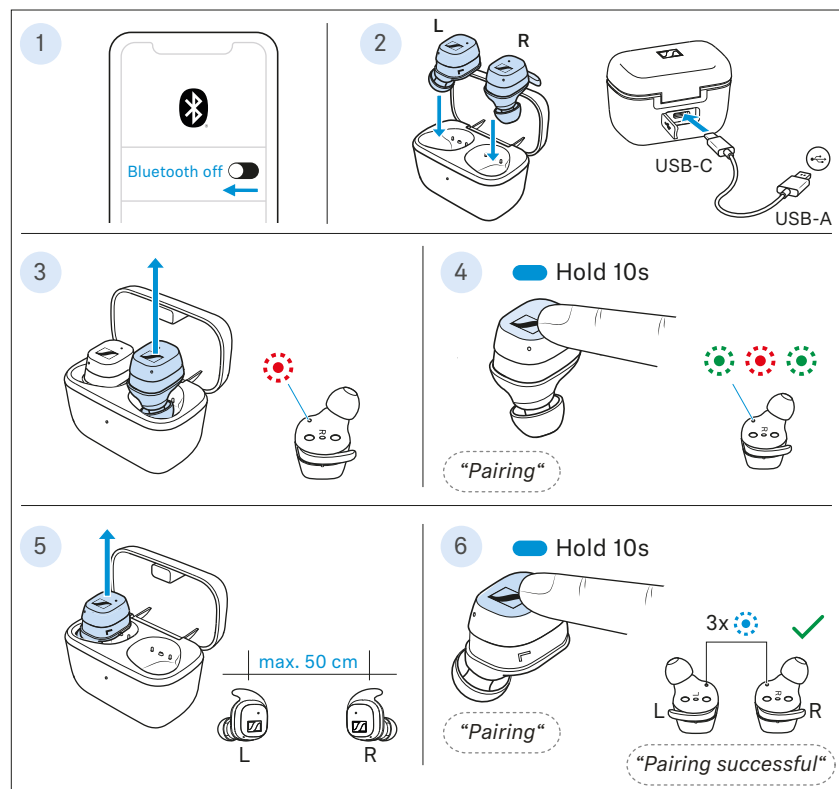

## Installing the Smart Control app

To make full use of all the settings and functions of the headphones, you need to have the free Sennheiser Smart Control app installed on your smartphone.

Download the app from the Apple App Store or Google Play and install it on your smartphone. Alternatively, you can use your smartphone to scan the following QR code or to call up the following Internet site:

[www.sennheiser-hearing.com/smartcontrol](http://www.sennheiser-hearing.com/smartcontrol)

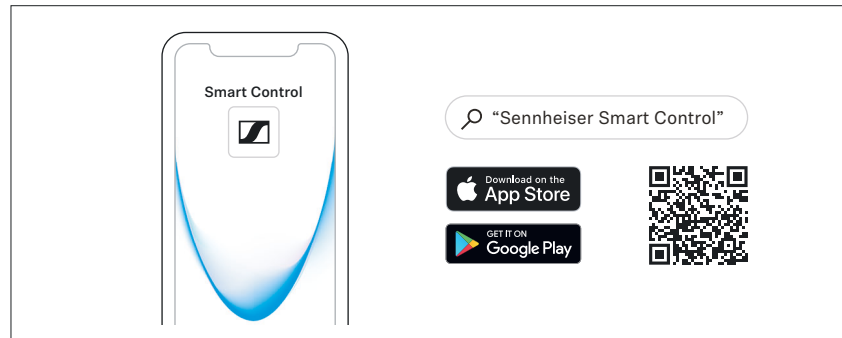

- ▷ Connect your smartphone to the earbuds using Bluetooth (> 15).
- ▷ Start the Smart Control app.
- ▷ Follow the instructions in the app.
- ▷ Simultaneously touch and hold the right and the left touch control panel for 3 seconds to accept the Bluetooth Low Energy connection.  
The Smart Control app recognizes the earbuds and activates all available settings and functions.

## Selecting suitable ear adapters and ear fins for optimum fit of the earbuds

The perceived sound quality including bass performance for the “Adaptable Acoustics” feature of the SPORT True Wireless depends to a large extent on the correct fit of the earbuds in the ear. Earbuds that fit perfectly in your ears do not fall out even during fast movements and, especially for “Focus” mode, the best possible noise cancellation is ensured.

- ▷ Pull the ear adapter away from the in-ear sound tunnel.
- ▷ Mount the new ear adapter (closed or open, more information in the following chapters) to the in-ear sound tunnel. Ensure that the ear adapter locks into place.
- ▷ Test which ear adapter size gives you the best sound quality for your “Adaptable Acoustics” setting and the best wearing comfort. You can choose between open and closed ear adapters in three different sizes: S, M and L.  
The ear adapters must fit securely in the ear canal and completely seal your ears (especially the closed ear adapters). You may need different ear adapter sizes for your right or left ear.
- ▷ In the Smart Control app, activate the mode that matches the open or closed ear adapters you are using under “Adaptable Acoustics” (> 23).

### Closed ear adapters for “Focus” mode

Use the closed ear adapters (with a black cross inside) for “Focus” mode to minimize your awareness of your surroundings and to fully immerse yourself in your favorite music, for example, when working out at the gym or at home.

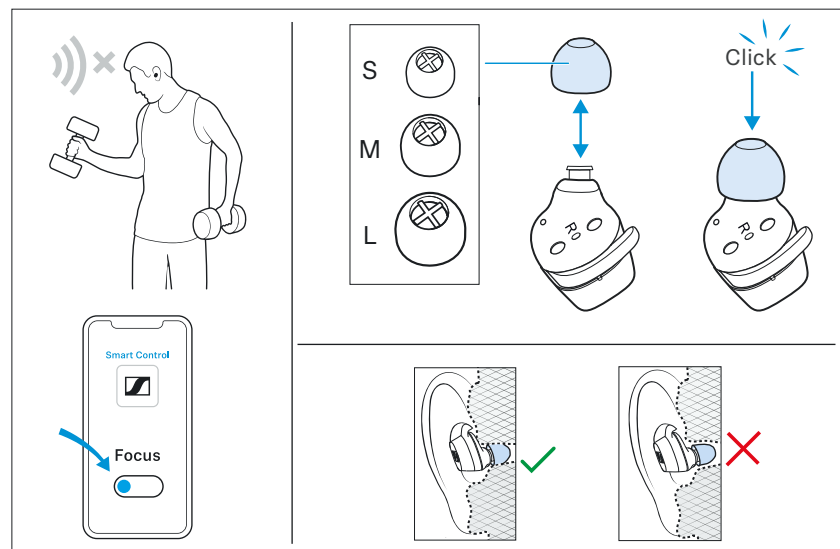

- ▷ In the Smart Control app, activate the “Focus” mode under “Adaptable Acoustics” (> 23).

### Open ear adapters for “Aware” mode

Use the open ear adapters (with blue marking inside) for “Aware” mode, for example to reduce body borne noise when running (breathing, footsteps, cloths rattling) and to be more aware of high sounds from your surroundings (car horn, bike bell, barking dog).

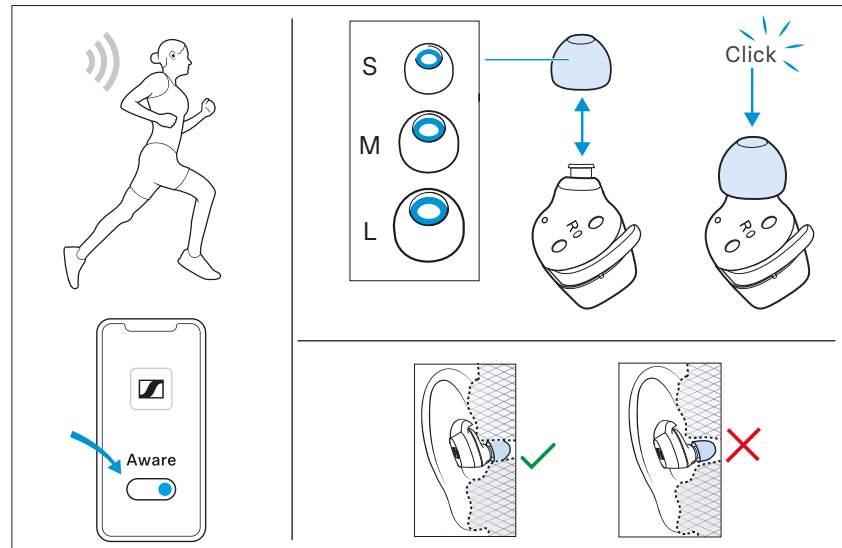

- ▷ In the Smart Control app, activate the “Aware” mode under “Adaptable Acoustics” (> 23).

### Silicone ear fins

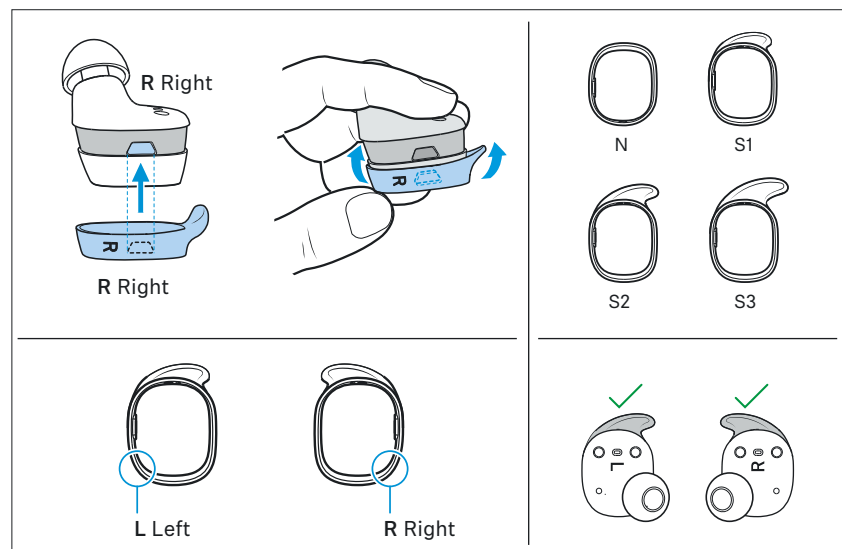

- ▷ Carefully remove the ear fin from the earbud housing.
- ▷ Assign the right and left ear fin to the right and left earbud (see embossing on the bottom).
- ▷ Place the latch on the inside of the ear fin ring into the recess provided on the earbud and slip the ring over the earbud housing. Make sure the ring fits neatly into the duct on the earbud housing.
- ▷ Test which ear fin size gives you the best fit and the best wearing comfort.  
You can choose between 3 different ear fins in size S1, S2 and S3. The ear fin holds the earbud securely in the rear part of the ear. If you do not want to use an ear fin, put size N on the earbud.

## Setting “Adaptable Acoustics” to match the ear adapters

Using the “Adaptable Acoustics” feature in Smart Control app and the open or closed ear adapters, you can optimally adapt the SPORT True Wireless to your application.

Note that both earbuds must be switched on to adjust the settings for both earbuds (right and left).

- ▷ If you use the closed ear adapters, activate “Focus” mode.
- ▷ If you use the open ear adapters, activate “Aware” mode (default setting upon delivery).

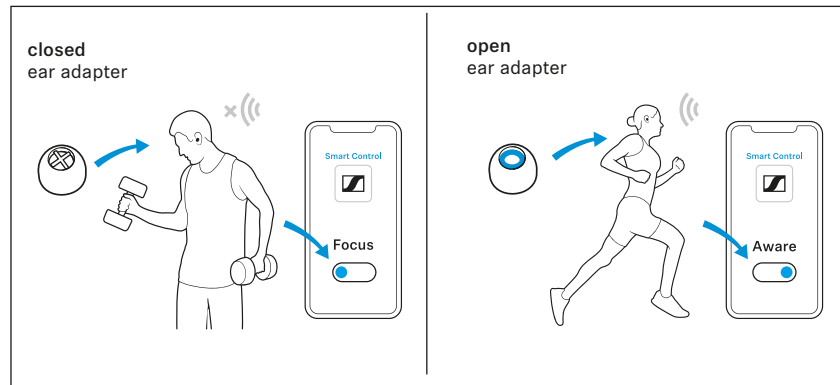

**i** If the “Adaptable Acoustics” settings in the Smart Control app and the mounted ear adapters do not match correctly, the SPORT True Wireless are fully usable, but the sound quality – especially the bass performance – is not optimal.

## Inserting the earbuds into the ears

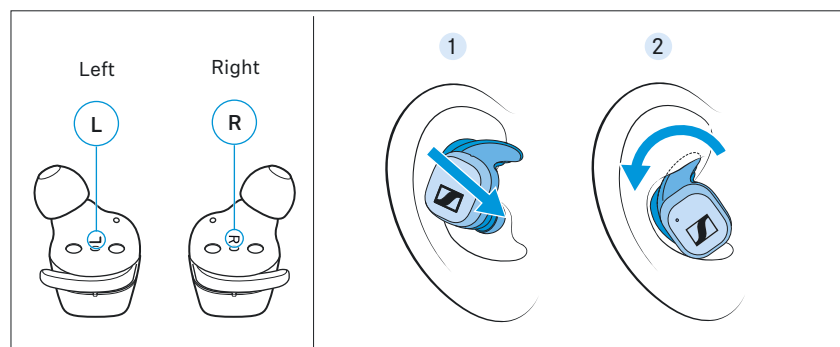

- ▷ Assign the right earbud to your right ear and the left earbud to your left ear.
- ▷ Insert the earbuds at a slight angle into the ears and twist them slightly into the ear canal so that they sit comfortably and snugly in the ear canal (> 21). If you are using an ear fin, make sure that the fin finds support in the auricle (> 21).

**i** The right or left earbud can be used alone. If you insert one earbud into the charging case during use, a short interruption of playback may occur in the other earbud.

## Switching the earbuds on



### WARNING

**Danger of hearing damage due to high volume levels!**

Listening at high volume levels can lead to permanent hearing defects.

- ▷ Before putting the headphones on, adjust the volume to a low level (> 25).
- ▷ Do not continuously expose yourself to high volume levels.

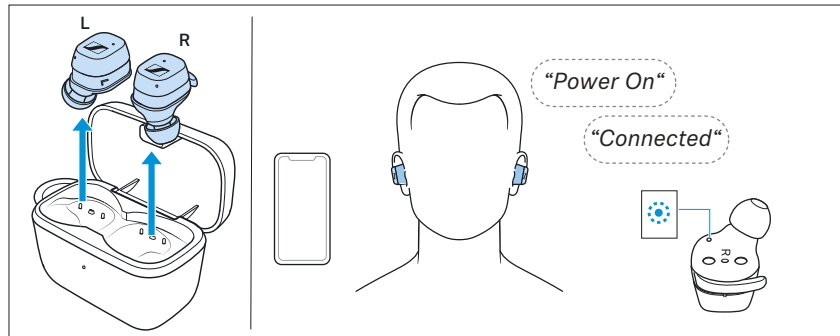

- ▷ Take both earbuds out of the charging case and insert them into your ears (> 23).

If a paired Bluetooth device is within the transmission range, you hear the voice prompts “Power On” and “Connected”. The LEDs of the earbuds light up blue.



If you take the earbuds out of the charging case during an incoming call, the call is automatically accepted and you can use the earbuds directly for making calls.

This Auto Call function can also be deactivated (> 29).



The earbuds automatically switch to idle mode if no paired Bluetooth device can be found within 15 minutes. You can wake up the earbuds from idle mode by touching their touch control panels 1x or by briefly inserting them into the charging case.



The charging case automatically switches to a power saving mode if the lid is open for more than 5 minutes. In power saving mode, inserted earbuds are not detected or switched on/off when they are removed/inserted.

Close the lid of the charging case and open it again to end power saving mode.



## Switching the earbuds off

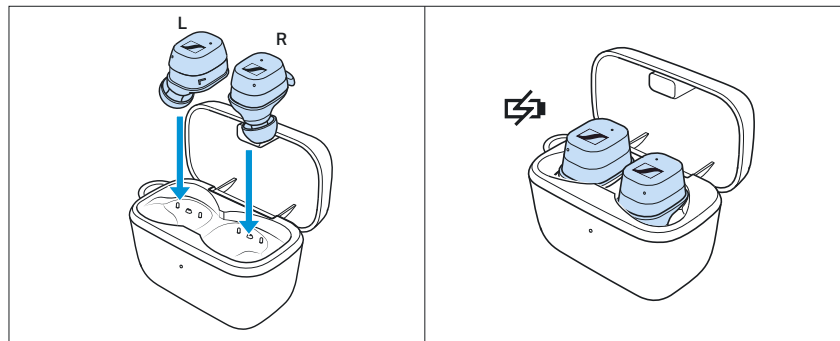

The earbuds do not have to be switched off explicitly.

- ▷ Insert the earbuds into the charging case to switch them off. As soon as the earbuds are inserted into the charging case, they switch off and are being charged (> 14).

**i** You can also manually switch off the earbuds (idle mode) via the Smart Control app.

**i** The earbuds automatically switch to idle mode if no paired Bluetooth device can be found within 15 minutes. You can wake up the earbuds from idle mode by touching their touch control panels 1x or by briefly inserting them into the charging case.

**i** The charging case automatically switches to a power saving mode if the lid is open for more than 5 minutes. In power saving mode, inserted earbuds are not detected or switched on/off when they are removed/inserted.

Close the lid of the charging case and open it again to end power saving mode.

## Adjusting the volume



### WARNING

**Danger of hearing damage due to high volume levels!**

Listening at high volume levels can lead to permanent hearing defects.

- ▷ Before putting the headphones on and before toggling between audio sources, adjust the volume to a low level.
- ▷ Do not continuously expose yourself to high volume levels.

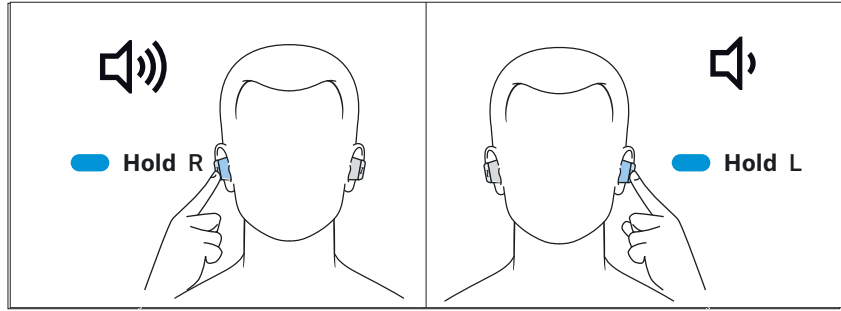

To increase the volume:

- ▷ Touch and hold the touch control panel of the right earbud until the volume is increased.

To reduce the volume:

- ▷ Touch and hold the touch control panel of the left earbud until the volume is reduced.

When the maximum or minimum volume is reached, you hear a beep.

**i** You can also adjust the volume using the connected Bluetooth device.



## Using the voice assistant/voice dialing

- ▷ Tap the touch control panel of the right or left earbud 3x. The available voice assistant of your smartphone is activated (\*depending on the system or app used on your smartphone: Siri, Google Assistant, ...).
- ▷ Ask the voice assistant your question or make a request.

To cancel the voice assistant/voice dialing:

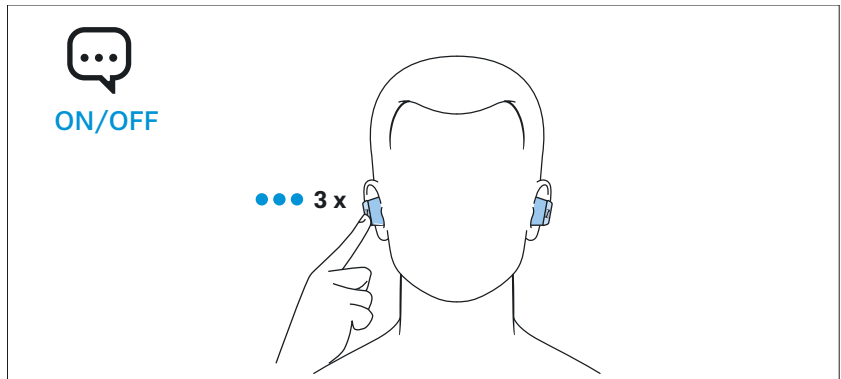
- ▷ Tap the touch control panel of the right or left earbud 3x.



Right or left touch control panel		Function
	Tap 3x 	Activates the voice assistant

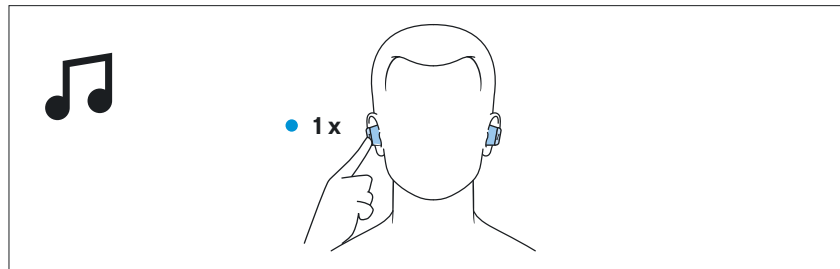

## Controlling music playback

The music playback functions are only available when the earbuds and the device are connected via Bluetooth. Some smartphones or music players may not support all functions.



### Playing/pausing music



▷ Tap the touch control panel of the right or left earbud 1x.

Right or left touch control panel		Function
	Tap 1x 	Plays or pauses music

### Playing the previous track

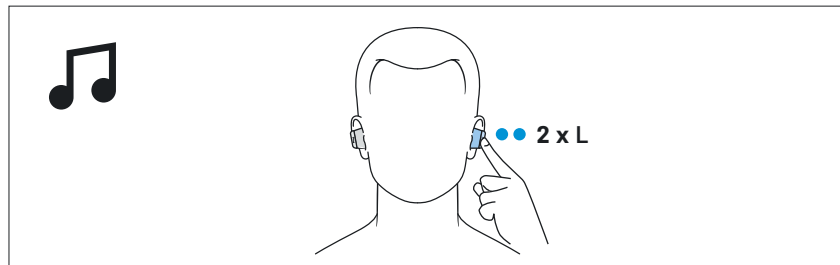
▷ Tap the touch control panel of the left earbud 2x.





Left touch control panel		Function
	Tap 2x 	Plays the previous track in the playlist

### Playing the next track

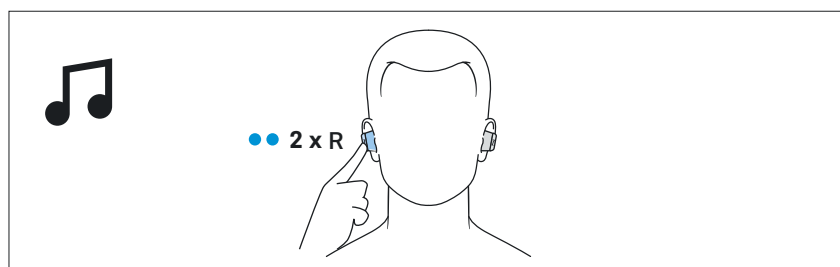
▷ Tap the touch control panel of the right earbud 2x.



Right touch control panel		Function
	Tap 2x 	Plays the next track in the playlist

## Making calls using the earbuds

The call functions are only available when the earbuds and the smartphone are connected via Bluetooth.

Some smartphones and telephony apps (e.g. WhatsApp, MS Teams, WeChat) may not support all call control functions.

During a call, you can use the **right and/or left earbud** to control the call functions.

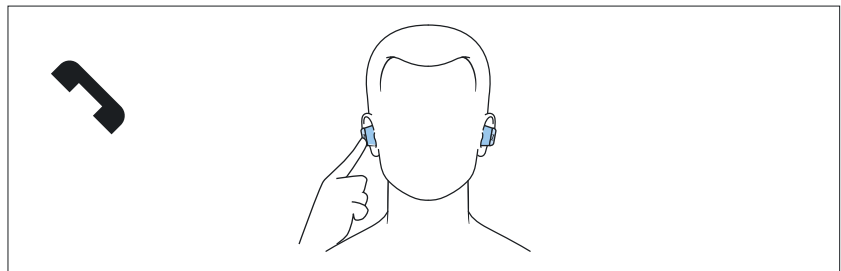











### Making a call

- ▷ Dial the desired number on your smartphone.  
If your smartphone does not automatically transfer the call to the headphones, select “SPORT True Wireless” as the output device on your smartphone (see the instruction manual of your smartphone if necessary).

### Accepting/rejecting/ending a call

If your headphones are connected to a smartphone and you receive a call, you hear a ring tone in the headphones.

If you are playing music when you receive a call, the music pauses until you end the call.

Right or left touch control panel		Function
	Tap 1x 	Accepts a call
	Tap 1x 	Ends a call Voice prompt “Call ended”
	Tap 2x 	Rejects a call Voice prompt “Call rejected”
	Tap 1x 	Accepts an incoming call and ends the active call
	Tap 2x 	Rejects an incoming call and continues the active call

## Using the Auto Call function

If you take the paired earbuds out of the charging case during an incoming call, the call is automatically accepted and you can use the earbuds directly for making calls.

You can activate (default setting) or deactivate the function via the Smart Control app. Note that both earbuds must be switched on to adjust the settings for both earbuds (right and left).

**i** The right or left earbud can be used alone. If you insert one earbud into the charging case during use, a short interruption of playback may occur in the other earbud.

## Using the Sidetone function

When using the earbuds for phone calls, you may find it more comfortable if your own voice is audible in the earbuds. With the Sidetone function activated, your own voice is played back through the earbuds during a phone call.

You can activate the function (default setting) and adjust settings or deactivate the function via the Smart Control app. Note that both earbuds must be switched on to adjust the settings for both earbuds (right and left).

**i** The right or left earbud can be used alone. If you insert one earbud into the charging case during use, a short interruption of playback may occur in the other earbud.

**i** The advantages of the Sidetone function are particularly noticeable when using the closed ear adapters.

## Displaying the battery charge status

When the earbuds are connected to your Bluetooth device, the battery charge status can be displayed on the screen of your smartphone or device (depending on the device and operating system used).

The Smart Control app also displays the charge status of the earbuds' rechargeable batteries.

### Displaying the battery charge status using the charging case

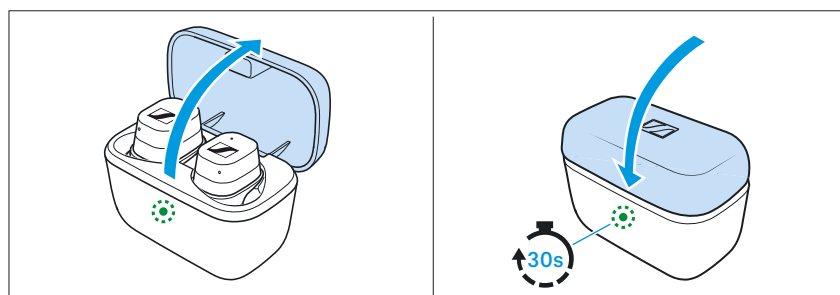





## Using the earbuds

If no USB cable is connected to the charging case:

- ▷ Open the lid of the charging case.

The LED of the charging case displays the battery charge status. If you close the lid of the charging case, the LED will go off after approx. 30 seconds.

LED		Charging case WITH earbuds inserted	Charging case WITHOUT earbuds inserted
	lights up green	... earbuds are fully charged and the charging case can still charge at least one complete cycle	... charging case is fully charged
	pulses yellow	... earbuds are being charged via the rechargeable battery of the charging case	–
	lights up yellow	... earbuds are fully charged, the charging case cannot charge another complete cycle	... charging case is charged less than 90 %
	lights up red	... rechargeable batteries of the earbuds and the charging case are almost empty	... rechargeable battery of the charging case is almost empty
	flashes red	... charging error/ battery error (> 34)	... charging error/ battery error (> 34)

## Adjusting sound effects/the equalizer

To be able to use the sound effects/equalizer, you require the Smart Control app (> 20).

- ▷ In the Smart Control app, select the desired sound effect via the equalizer. You can use predefined presets or define your own settings.

The sound effects are stored in the earbuds. These sound settings are active even without using the Smart Control app, i.e. when you are using a different Bluetooth device. Note that both earbuds must be switched on to adjust the settings for both earbuds (right and left).



The Sound Check function of the Smart Control app allows you to create customized equalizer presets. Sound Check guides you step by step to the optimal results.

## Setting the voice prompts/beep sounds

To be able to set the voice prompts and beep sounds, you require the Smart Control app (> 20).

You can choose between voice prompts and beep sounds, or deactivate the status messages with a few exceptions (e.g. rechargeable battery is empty). Note that both earbuds must be switched on to adjust the settings for both earbuds (right and left).

## Customizing the control functions

To be able to customize the control functions for music playback, you require the Smart Control app (> 20).

The app allows you to customize the control functions and other commands of the earbuds, to select preset control functions or to switch off the control functions. Some basic functions cannot be changed (e.g. call control).

## Storing or transporting the earbuds in the charging case

Store the earbuds in the charging case to prevent damage to the earbuds when not in use or during transport. The earbuds are automatically charged in the charging case so you always have the full battery life to work with.

- ▷ Open the charging case by overcoming a slight magnetic resistance and insert the left earbud into the left charging compartment and the right earbud into the right charging compartment. The earbuds are magnetically pulled into the charging compartments.
- ▷ Close the lid of the charging case.

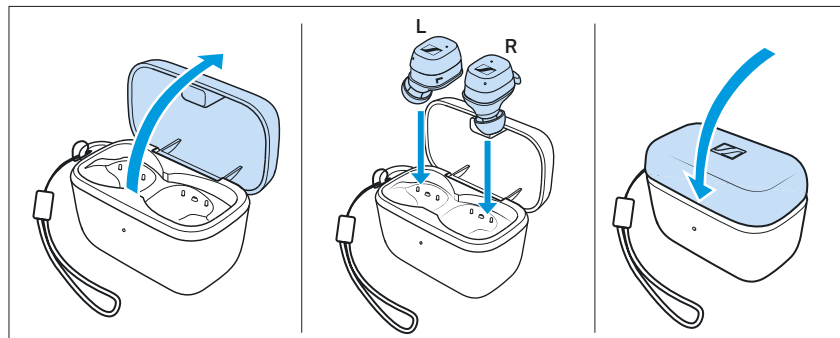

- i** Make sure that the protective cover of the USB socket of the charging case is always closed to protect the socket from dust and dirt.



## Care and maintenance of the earbuds/charging case

### CAUTION

Liquids can damage the electronics of the product!

Liquids entering the housing of the product can cause a short-circuit and damage the electronics.

- ▷ Keep all liquids far away from the product.
  - ▷ Do not use any solvents or cleansing agents.
- 
- ▷ Only clean the charging case with a soft, dry cloth.
  - ▷ Clean the earbuds with a slightly damp cloth.
  - ▷ You can clean the silicone ear adapters (open or closed) and silicone ear fins under lukewarm running water. Let the ear adapters and ear fins dry at room temperature for at least 12 hours before re-attaching them to the earbuds.
  - ▷ Clean the charging contacts on the earbuds and in the charging case from time to time using e.g. a cotton swab.

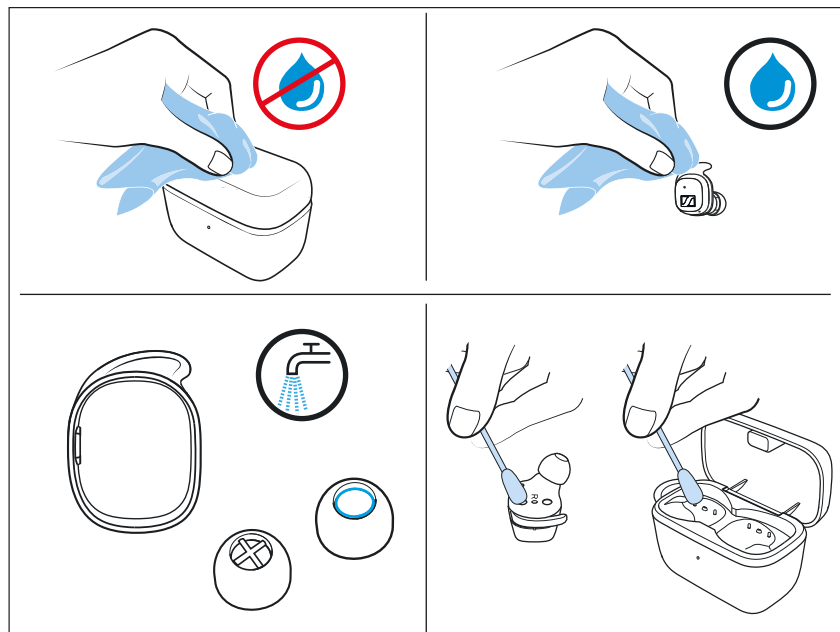

If the earbuds have gotten wet:

- ▷ Remove the ear adapters and dry the earbuds and ear adapters with a dry cloth. If necessary, let the earbuds and ear adapters dry at room temperature for approx. 12 hours.

## Replacing the ear adapters and ear fins

For reasons of hygiene, you should replace your ear adapters and ear fins from time to time. Spare ear adapters and spare ear fins can be found on the SPORT True Wireless product page at [www.sennheiser-hearing.com](http://www.sennheiser-hearing.com).

- ▷ Pull the ear adapter away from the in-ear sound tunnel.
- ▷ Mount the new ear adapter to the in-ear sound tunnel. Ensure that the ear adapter locks into place.

- ▷ Carefully remove the ear fin from the earbud housing.
- ▷ Slip the new ear fin onto the earbud. Make sure that the latch on the inside of the ear fin ring is placed in the recess provided on the earbud housing (> 22).

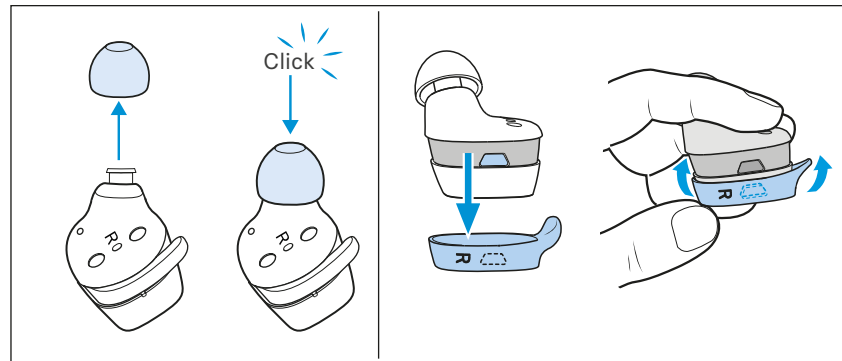

## Information on the built-in rechargeable battery

Sonova Consumer Hearing ensures and guarantees that the rechargeable batteries perform at their optimum upon purchase of the product. If, upon purchase or within the warranty period, you suspect that a rechargeable battery is obviously defective or if a charging error/battery error is displayed (> 8), stop using the product, disconnect it from the power supply system and contact your Sonova Consumer Hearing partner. Your Sonova Consumer Hearing partner will coordinate the repair/replacement with you.

Do not return a product with a defective battery to your dealer or Sonova Consumer Hearing partner unless requested to do so. To find a partner in your country, search at [www.sennheiser-hearing.com/service-support](http://www.sennheiser-hearing.com/service-support).

At the end of its operational lifetime, this product with its built-in rechargeable battery must be disposed of separately from normal household waste. You can find more information here: > 39.

## Installing firmware updates

Firmware updates can be downloaded free of charge from the Internet using the Sennheiser Smart Control app.

- ▷ Connect your earbuds to your smartphone and start the Smart Control app (> 20).
- ▷ The app provides information on available firmware updates and guides you through the installation process.
- ▷ Make sure that the batteries are fully charged before updating (> 14). Avoid connecting or disconnecting the USB power supply during the update process.
- ▷ The earbuds must be in the charging case and must not be removed during the update process. Close the lid of the charging case.

## FAQ/If a problem occurs ...

If a problem has occurred, proceed in the following order until the problem is solved and you can use the earbuds again:

1. Insert the earbuds into the charging case and close the lid. Wait for at least 10 seconds (> 35).
2. Connect the earbuds to the Smart Control app to install the latest firmware (> 20).
3. Check the list of frequently asked questions to see if there is a solution to the problem (> 35).
4. Reset the earbuds to the factory default settings (> 36).
5. Contact your Sonova Consumer Hearing partner to solve the problem (> 35).

### Current list of frequently asked questions (FAQ)

Visit the SPORT True Wireless product page at

[www.sennheiser-hearing.com/sport-true-wireless](http://www.sennheiser-hearing.com/sport-true-wireless)

There you will find a current list of frequently asked questions (FAQ) and suggested solutions.



### Your question has not been answered or the problem persists?

If a problem occurs that is not listed in the FAQ section or if the problem cannot be solved with the proposed solutions, please contact your Sonova Consumer Hearing partner for assistance.

To find a partner in your country, search at [www.sennheiser-hearing.com/service-support](http://www.sennheiser-hearing.com/service-support).

### Leaving the Bluetooth transmission range

Wireless calling and streaming are only possible in the Bluetooth transmission range of your smartphone. The transmission range largely depends on environmental conditions such as wall thickness, wall composition etc. With a free line of sight, the transmission range of most smartphones and Bluetooth devices is up to 10 meters. If you, and therefore the earbuds, leave the Bluetooth transmission range of the smartphone, the sound quality deteriorates increasingly until you hear the voice prompt “No connection” and the connection breaks down completely. If you immediately re-enter the Bluetooth transmission range, the connection is automatically re-established and you hear the voice prompt “Connected”. If this is not the case, tap the touch control panel of the earbud 1x.

### Resetting the earbuds

If the function of the earbuds is disturbed, perform a reset. Individual settings such as the pairing settings are not deleted.

- ▷ Insert both earbuds into the charging case, close the lid of the charging case and wait at least 10 seconds before taking the earbuds out of the charging case and switching them on again.

### Resetting the earbuds to the factory default settings

If the function of the earbuds is disturbed and a reset (> 35) does not improve, reset the earbuds to the factory default settings. This deletes, among other things, all pairing settings.

- ▷ You can reset the earbuds to the factory default settings using the Smart Control app.
- ▷ If the Smart Control app is not available, pair the earbuds with each other (> 18).

# Specifications

## SPORT True Wireless

Model: CX200TW1, CX200TW1 C, CX200TW1 L, CX200TW1 R

Wearing style	True Wireless stereo earbuds
Ear coupling	ear canal, closed-back
Frequency response	5 Hz to 21 kHz
Transducer principle	dynamic
Transducer size	7 mm
Sound pressure level (SPL)	110 dB (1 kHz/0dBFS)
THD (1 kHz, 94 dB SPL)	< 0.08 %
Microphone principle	MEMS
Microphone frequency response	100 Hz to 10 kHz
Microphone pick-up pattern (speech audio)	2-mic beamforming array
Power supply	built-in Lithium rechargeable batteries, 3.7 V --- earbuds: 55-72 mAh charging case: 400-420 mAh USB charging via USB-C socket of the charging case: 5 V ---, 600 mA
Operating time	9 hrs with rechargeable battery of the earbud (test conditions: iPhone within 1 m distance, Bluetooth AAC codec, playback of mixed music, volume level 50 %, no EQ settings); 27 hrs with rechargeable battery of the charging case
Charging time of rechargeable batteries	approx. 1.5 hrs
Temperature range	<i>operation:</i> 0 to +40 °C <i>storage:</i> -25 to +70 °C
Relative humidity	<i>operation:</i> 10 to 80 %, non condensing <i>storage:</i> 10 to 90 %
Magnetic field strength	earbuds: 64 mT charging case: 177 mT
Weight	earbuds: approx. 6 g each charging case: approx. 37 g

## Bluetooth

Version	Bluetooth 5.2 compatible, class 1
Transmission frequency	2,402 MHz to 2,480 MHz
Modulation	GFSK, $\pi/4$ DQPSK, 8DPSK
Profiles	HFP, AVRCP, A2DP
Output power	10 mW (max)
Codec	aptX®, AAC, SBC

## Specifications

Device name	SPORT True Wireless (individually adjustable via the Smart Control app)
Number of active connections	1

# Manufacturer declarations

## Warranty

Sonova Consumer Hearing GmbH gives a warranty of 24 months on this product.

For the current warranty conditions, please visit our website at [www.sennheiser-hearing.com/warranty](http://www.sennheiser-hearing.com/warranty) or contact your Sonova Consumer Hearing partner.

## In compliance with the following requirements

- General Product Safety Directive (2001/95/EC)
- Compliant to **Sound Pressure Limits** according to country specific requirements

## EU declaration of conformity



- RoHS Directive (2011/65/EU)

Hereby, Sonova Consumer Hearing GmbH declares that the radio equipment type CX200TW1 (CX200TW1 R, CX200TW1 L, CX200TW1 C) is in compliance with the Radio Equipment Directive (2014/53/EU).

The full text of the EU declaration of conformity is available at the following Internet address: [www.sennheiser-hearing.com/download](http://www.sennheiser-hearing.com/download).

## UK declaration of conformity



- RoHS Directive (2011/65/EU)
- Radio Equipment Regulations (2017)

## Notes on disposal



- EU: WEEE Directive (2012/19/EU)
- EU: Battery Directive (2006/66/EC & 2013/56/EU)
- UK: WEEE Regulations (2013)
- UK: Battery Regulations (2015)

The symbol of the crossed-out wheeled bin on the product, the battery/rechargeable battery (if applicable) and/or the packaging indicates that these products must not be disposed of with normal household waste, but must be disposed of separately at the end of their operational lifetime. For packaging disposal, observe the legal regulations on waste segregation applicable in your country. Improper disposal of packaging materials can harm your health and the environment.

The separate collection of waste electrical and electronic equipment, batteries/rechargeable batteries (if applicable) and packagings is used to promote the reuse and recycling and to prevent negative effects on your health and the environment, e.g. caused by potentially hazardous substances contained in these products. Recycle electrical and electronic equipment and batteries/rechargeable batteries at the end of their operational lifetime in order to make contained recyclable materials usable and to avoid littering the environment.

## Manufacturer declarations

If batteries/rechargeable batteries can be removed without damaging them, you are obliged to dispose of them separately (for the safe removal of batteries/rechargeable batteries, see the instruction manual of the product). Handle lithium-containing batteries/rechargeable batteries with special care, as they pose particular risks, such as the risk of fire and/or the risk of ingestion in the case of coin batteries. Reduce the generation of battery waste as much as possible by using longer-life batteries or rechargeable batteries.

Further information on the recycling of these products can be obtained from your municipal administration, from the municipal collection points, or from your Sonova Consumer Hearing partner. You can also return electrical or electronic equipment to distributors who have a take-back obligation. Herewith you make an important contribution to the protection of the environment and public health.

### Trademarks

Apple, iPhone, the Apple logo and Siri are trademarks of Apple Inc., registered in the U.S. and other countries. App Store is a service mark of Apple Inc. The trademark “iPhone” is used in Japan with a license from Aiphone K.K.

Google Play and the Google Play logo are trademarks of Google LLC. The Bluetooth® word mark and logos are registered trademarks owned by Bluetooth SIG, Inc. and any use of such marks by Sonova Consumer Hearing GmbH is under license.

Qualcomm aptX is a product of Qualcomm Technologies International, Ltd. Qualcomm is a trademark of Qualcomm Incorporated, registered in the United States and other countries, used with permission.

aptX is a trademark of Qualcomm Technologies International, Ltd., registered in the United States and other countries, used with permission.

Other product and company names mentioned in the user documentation may be the trademarks or registered trademarks of their respective holders.